

**System Dynamics Modeling
for Pro-Active Intelligence (PAINT)**

Ed Anderson
Nazli Choucri
Daniel Goldsmith
Stuart Madnick
Michael Siegel
Dan Sturtevant

Working Paper CISL# 2009-17

November 2009

Composite Information Systems Laboratory (CISL)
Sloan School of Management, Room E53-320
Massachusetts Institute of Technology
Cambridge, MA 02142

System Dynamics Modeling for Pro-Active Intelligence

Massachusetts Institute of Technology
Sloan School of Management
Political Science Department
Engineering Systems Division

BAA-07-01-IFKA

Proactive Intelligence (PAINT)

FINAL REPORT

Draft: as of February 2, 2009
(updated as of November 4, 2009)

Ed Anderson
Nazli Choucri
Daniel Goldsmith
Stuart E. Madnick
Michael Siegel
Dan Sturtevant

CONTRACT FA8750-07-C-0101
ISSUED BY AFRL/IFKE CODE FA8750 6.
ADMINISTERED BY CODE N62879
USAF, AFMC
AIR FORCE RESEARCH LABORATORY
26 ELECTRONIC PARKWAY
ROME NY 13441-4514

Table of Contents

Abstract.....	2
1. Introduction.....	3
2. Background and Context.....	4
3. Modeling for Pro-Active Intelligence.....	6
4. Modeling Resources as Part of an Integrated Multi-Methodology System.....	17
5. Formalizing Pro-Active Intelligence Probes.....	22
6. Conclusion.....	23
Acknowledgement.....	24
References:.....	25
Appendix A: Full Simulation Model Equations.....	27
Appendix B: Documentation for Resource Model in Integrated System.....	33
List of Acronyms.....	43

Table of Figures

<i>Figure 1. Roadmap of Technology Determinants.....</i>	<i>5</i>
<i>Figure 2. Causal Framework for Nefarious Activities.....</i>	<i>8</i>
<i>Figure 3. Causal Framework for Nefarious Activities.....</i>	<i>9</i>
<i>Figure 4. Leadership Inputs.....</i>	<i>10</i>
<i>Figure 5. External Inputs.....</i>	<i>11</i>
<i>Figure 6. Resource Inputs.....</i>	<i>12</i>
<i>Figure 7. Developing probe candidates.....</i>	<i>13</i>
<i>Figure 8. Probe Results.....</i>	<i>14</i>
<i>Figure 9. Base Case.....</i>	<i>14</i>
<i>Figure 10. Probe Results with Low Leadership Consolidation.....</i>	<i>15</i>
<i>Figure 11. Probe Results Showing Both Low and High Leadership Consolidation.....</i>	<i>15</i>
<i>Figure 12. Observable Data With and Without Simulation Analysis.....</i>	<i>16</i>
<i>Figure 13. Summary of Probe Methodology and Results.....</i>	<i>16</i>
<i>Figure 14. Simple Integration Structure.....</i>	<i>17</i>
<i>Figure 15. Resource Model Overview.....</i>	<i>18</i>
<i>Figure 16. Sample Probe Narrative.....</i>	<i>18</i>
<i>Figure 17. Resource Probe Simulation Output.....</i>	<i>19</i>
<i>Figure 18. Illustrative Resource Structure.....</i>	<i>20</i>
<i>Figure 19. Supplier Model Structure.....</i>	<i>21</i>
<i>Figure 20. Supplier Vulnerability.....</i>	<i>21</i>
<i>Figure 21. Formalized Probe Strategy.....</i>	<i>22</i>
<i>Figure 22. Overview of Methodology.....</i>	<i>23</i>

System Dynamics Modeling for Pro-Active Intelligence

Abstract

The Pro-Active Intelligence (PAINT) program, sponsored by the Intelligence Advanced Research Projects Activity (IARPA), was formed to address the challenges¹ posed by distributed human networks, including terrorists and insurgencies, both independent and state-sponsored. In particular, certain threats (including emerging dual-use technologies) are difficult to detect using traditional intelligence means because: (a) indicators are difficult to discern and may give little warning time, (b) there is usually limited relevant data collection and integration capability, and (c) expertise is generally diverse and disconnected.

Over the course of 18 months from September 2007 to February 2009, an effort, led by researchers from MIT, was initiated to develop computational social science models to study and understand the dynamics of complex intelligence targets for nefarious technology activities (broadly defined as activities outside U.S. national interest). System dynamics models were developed because they offered great opportunities to (a) understand and represent determinants of nefarious technology development, (b) to identify aspects of critical pathways, such as resource management, towards the development of nefarious technologies, and (c) support a modeling based strategy for the identification of new sources of intelligence.

This report describes the “System Dynamics Modeling for Pro-Active Intelligence” effort and its two thrusts: (a) development of a comprehensive holistic system dynamics model to represent, understand, and differentiate nefarious and benign activities and (b) the development of a detailed system dynamics resource model that can be used as a component of a multi-method federation of models. In both cases, simulations were conducted to illustrate the effectiveness of these models in demonstrating system behavior and, on occasion, highlighting potentially counter-intuitive behaviors.

¹ From <http://www.icairst.org/docs/2007-10-03/Bush%20IARPA%20Brief%20Oct%202007.pdf>

1. Introduction

Emerging technology activities in various parts of the world are a source of threat to U.S. national security. In particular, certain threats (including emerging dual-use technologies, such as nanotechnology) are difficult to detect using traditional means. In its introduction, the Report of the Joint Defense Science Board Intelligence Science Board Task Force on Integrating Sensor-Collected Intelligence states: “*The evolving international security landscape has become much more complicated, diverse, distributed and challenging...This evolving landscape presents many [intelligence, surveillance, and reconnaissance] ISR challenges.*” [Office of the Under Secretary of Defense for Acquisitions, Technology, and Logistics, 2008] While every case is unique, there are common processes tending toward threat development which can help point to new sources of intelligence information. Given current realities and uncertainties, “better operational preparedness” can be achieved by identifying, controlling and managing the linkages and situational factors that can promote the development and use of emerging technologies.

Over the course of 18 months from September 2007 to February 2009, an effort, led by researchers from MIT, worked with IARPA²—as part of the Pro-Active Intelligence (PAINT) program—to develop computational social science models to study and understand the dynamics of complex intelligence targets for nefarious technology activities (broadly defined as activities outside U.S. national interest). The MIT team developed system dynamics models³ to (a) understand and represent determinants of nefarious technology development, (b) to identify aspects of critical pathways, such as resource management, towards the development of nefarious technologies, and (c) support a modeling based strategy for the identification of new sources of intelligence.

In this report, we review the way in which we have modeled the context surrounding the development of nefarious technologies. More specifically, we articulate a modeling based strategy to utilize system dynamics in the targeting and collection of active intelligence, defined as “an action or stimulus designed to produce system behaviors (active probe) or to collect data (passive probe) that allow analysts to distinguish the existence of a specific condition (e.g., the existence of plans for the nefarious use of a capability).”⁴ The collection of this information would particularly aid in the disambiguation of intentions regarding dual-use technologies, in which existing information neither confirms nor disconfirms hypothesis regarding threat, or in “closed” situations in which traditional intelligence is scarce.

² Intelligence Advanced Research Projects Activity

³ Explained in Section 2.2

⁴ Adapted from internal program memo

2. Background and Context

We begin by placing the key issues in context, first by noting insights from the social sciences and then by highlighting some key system dynamics modeling features.

2.1 Determinants of Nefarious Technology Development

The development of nefarious technologies is a process shaped by several determinants, and there are multiple modes of technology development as well as different paths toward a range of technology ‘end points’. To begin, we identify three general classifications of determinants towards nefarious technology development: internal, external, and technological. These determinants are adapted from the context of nuclear proliferation developed in *The Correlates of Nuclear Proliferation: A Quantitative Test* [Singh and Way, 2004], and form a starting point for modeling nefarious technologies. Internal determinants emphasize a variety of domestic factors, including leadership, methods for control, and physical inputs such as production capacity, equipment, raw materials, and workforce. External determinants emphasize the incentives or disincentives provided by the security environment. Technological determinants emphasize the role that characteristics of particular technologies play in the nefarious and benign applications, such as cost, stage of development, and economic benefits.

In general, internal determinants, subject to leadership, steering, and coordination, can be combined to create a *feasible* level of technology development. Countries or organizations with high-levels of inputs (such as a highly-trained workforce) and extensive steering mechanisms (such as private-public research partnerships) will, on average, be able to coordinate and develop more complex technologies. The feasible level of technological development will constrain desired development of technology, both benign and nefarious. Technological determinants will further shape the direction of development. For example, certain biotechnologies may have greater overlap between benign and nefarious applications than nuclear technologies. Both the internal and technological determinants operate in a context which includes external actors that can alter internal determinants (through aid or tariffs) or technological determinants (through international treaties or organizations). The broad relationship among determinants is shown in Figure 1.

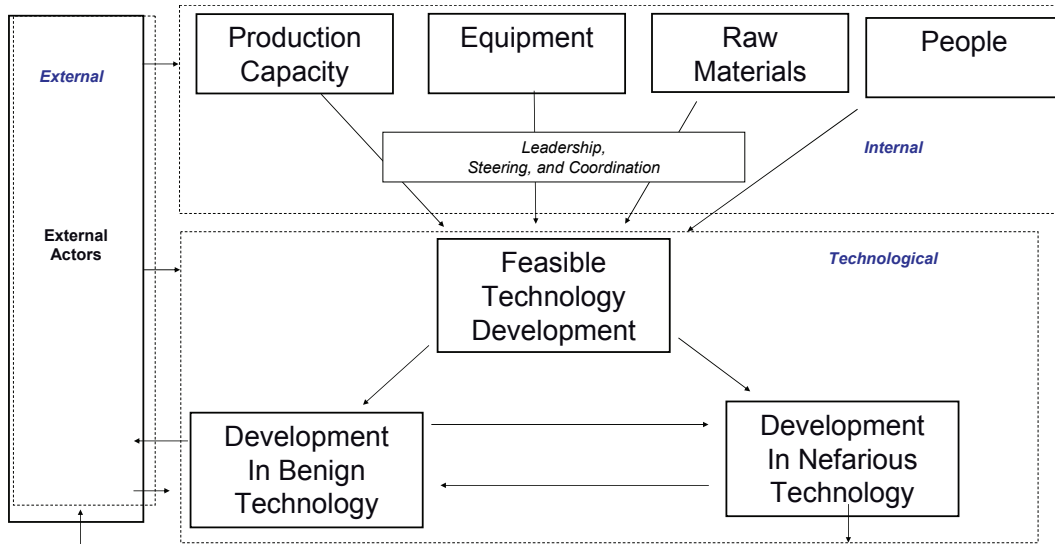

Figure 1. Roadmap of Technology Determinants

2.2 System Dynamics

We utilize the system dynamic modeling methodology to model the dynamics of technology development and detection. The following description of system dynamics can also be found in “*Linkages between Pre- and Post-Conflict: Exploiting Information Integration and System Dynamics.*” [Chourci et al, 2006] “System dynamics is an approach for modeling and simulating (via computer) complex physical and social systems and experimenting with the models to design policies for management and change [Forrester, 1958]. The core of the modeling strategy is representation of system structure in terms of *stocks* and of *flows*. In this connection, *feedback* loops are the building blocks for articulating the dynamics of these models and their interactions can represent and explain system behavior.

Created by Jay Forrester, system dynamics modeling (SDM) has been used as a method of analysis, modeling and simulation for over 50 years. SDM has been used for a wide range of purposes, such as to capture the dynamic relationship of energy and the economy [Sterman, 1981], to model the world petroleum market over a period of three decades [Choucri, 1981], to explore dynamics of economic growth [Choucri and Bousefield, 1978] to analyze the environmental implications of international trade [Lofdahl, 2002], to understand supply-chain management [Angerhofer and Angelides, 2000], to analyze different policies for nation-building [Robbins, 2005], to model software development [Abdel-Hamid and Madnick, 1991], and to examine the intricacies of the Air Force command and control systems [Lofdahl, 2005].

SDM offers unique capabilities to contribute to social science, economics, or political science modes of analysis. SDM recognizes the complex interactions among many feedback loops, rejects notions of linear cause-and-effect, and requires the analyst to view a complete system of relationships whereby the ‘cause’ might also be affected by the ‘effect’. SDM enables analysts to uncover ‘hidden’ dynamics. Moreover, SDM allows

the analyst an increased level of flexibility as SDM utilizes both conceptual understanding as well as empirical data collection. As Forrester explains, “the first step [in SDM] is to tap the wealth of information that people possess in their heads. The mental data base is a rich source of information about the parts of a system, about the information available at different points in a system, and about the policies being followed in decision making.” [Forrester, 1991]

The system dynamics modeling process translates these elements of causal logic into systems of difference equations and differential equations [Forrester, 1980]. Empirical analysis is also used to explain the relationships between individual elements in the overall system. By understanding the dynamics of a system, including interactions among actors, actions, structures and processes in complex environments, one can better identify how to reinforce a state’s capabilities while diminishing the loads and pressures exerted upon it.

3. Modeling for Pro-Active Intelligence

3.1 Overview of Process

We address the dynamics of technology policy and support the identification of opportunities for active intelligence through combining two modeling strategies: (a) developing an independently operating system dynamics model (with potential extensions in other modeling methodologies noted), and (b) modeling a specific area of interest (resources) as part of an integrated multi-methodology system. The first approach represents a potential holistic framework to develop and analyze opportunities in active intelligence. The second approach drills down on the role of resources in an integrating production system and exchanges information across modeling methodologies (such as agent base modeling and discrete event simulation). The section below details the first approach; details of the second approach appear in Section 4.

3.2 Proof of Concept: Holistic SDM for Active Intelligence

For modeling purposes, the first step is to define the *overall domain* and system of elements that contribute to the development of nefarious technologies (see Figure 1). This step yields a high level view that is used for framing purposes, consistent with lines of thinking in the social sciences. The next step is to select and ‘drill down’ on potential narratives to develop a ‘causal diagram’ that shows the processes active in the overall system.

We have created a high-level causal loop diagram that captures the key elements of the system in question including the major feedback loops. Unlike in traditional social science, in this diagram there is no one ‘dependent variable’ that reflects the overall stability status of the state; rather there are a whole range of potentially significant joint dependencies that capture overall system behavior and performance.

3.3 Causal Mapping

The nature of research in this area makes it difficult to derive the causal specifications on specific case studies. However, we have identified one *potential* archetype shown in Figure 2. This causal mapping *doesn't* preclude extensions or modifications for potential case studies; its use is to demonstrate a starting point for modeling nefarious technology activities holistically. Alternative cases exist in which the polarities (causal relations) may be different; however, the logic captured here articulates one integrated theory-driven view of the pressures towards and against nefarious activities. When applied to alternative case studies, modifications and additions would be necessary. The main function of this section is to demonstrate the methodology by which causal relations can be developed into a roadmap that assists in quantitative model development.

Our formulation draws upon diverse literature across determinants: a) threat and threat perceptions: [Jervis, 1970; 1971], [North, 1990], [Holsti, 1962; 1972], [George, 1969; 1980], [Schelling, 1963]; b) leadership: [Allison, 1969], [Allison and Zelikow, 1999], [Almond and Powell, 1966], [Wilson, 1989]; c) economic costs: [Weil, 2005], [Rodrik, 2007]; and d) technology pathway connections: [Wildavsky, 1988]; [Jervis, 1997].

In Figure 2, four feedback loops are shown, labeled either “R” for reinforcing feedback (increasing x causes more x), or “B” for balancing feedback (increasing x causes less x). Loop B1 captures one intended rationale for developing a nefarious program (or stockpile). In the notional case B1 selected, nefarious capabilities increase the deterrent effect to external threats, thus lowering or balancing the perceived threat and the necessity for future nefarious activity. Loop R1 provides another driver of nefarious development—government consolidation. The logic here is as follows: as government consolidation (alignment of leadership towards a certain goal) increases, it allows for the expansion of nefarious capabilities and development. This reduces external threat through the deterrence effect, and allows for even greater consolidation (the reinforcing effect).

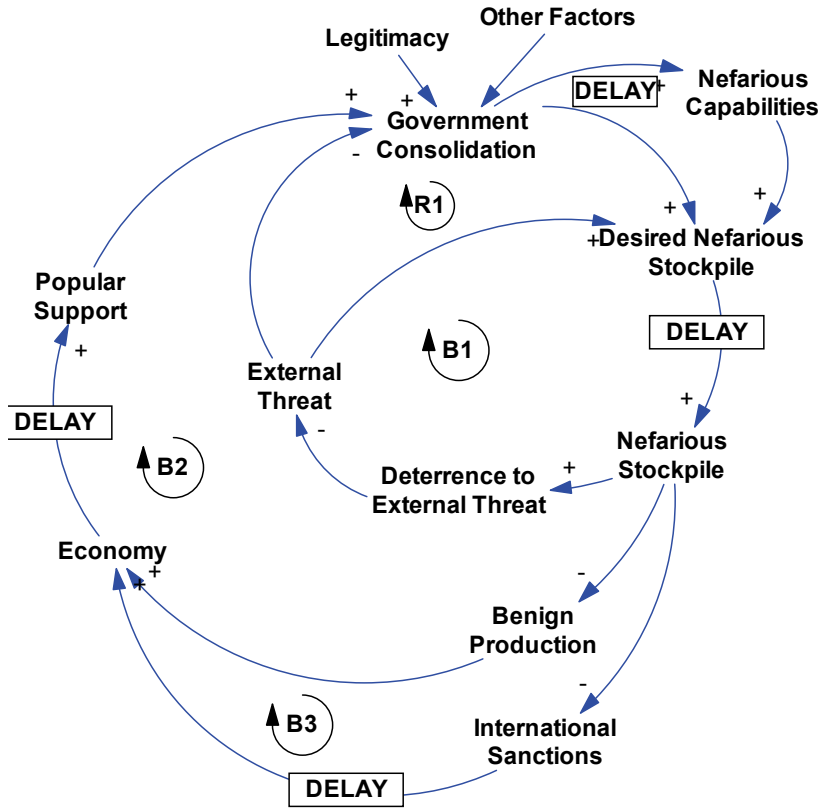

Figure 2. Causal Framework for Nefarious Activities

The logic in loops B2 and B3 show key constraints on the development of nefarious technologies. In B2, developing a nefarious stockpile has the consequence of limiting benign production, which would have otherwise returned economic gains. As economic costs accrue from pursuing nefarious development, popular support diminishes, reducing government consolidation and the desire to pursue nefarious development. Similarly, international sanctions (loop B3) in response to nefarious development can negatively impact the economy, and act through the same pathway as loop B2 to constrain nefarious development.

Taken as a whole, the causal loops represent a range of potential dynamics in nefarious development. In each particular case, each loop will operate differently; for example, some regimes will be more responsive to sanctions than others, and the same regime will vary its response depending on other prevailing conditions. However, developing a causal framework allows for a common platform to compare and contrast different narratives. In cases in which the logic fails to explain observed behavior, additions and modifications will be necessary.

3.3 Simulation Model

The task after developing the initial causal logic is to formulate the overall computational system dynamics model for simulation and analytic purposes. The computational system

itself consists of interconnected modules that represent different facets of the overall processes at hand.

Our model is constructed of four major subsections: a) benign/nefarious production; b) leadership decision making; c) external actors; and d) resource inputs. We discuss each subsection below by showing partial visuals of the integrated system. The complete listing of equations can be found in Appendix A.

An overview of the production subsection is shown in Figure 3. The overarching logic is that resource inputs define a potential level of production, which can be allocated in different fractions to benign or nefarious production. Starting at the bottom of the figure, four production inputs (raw materials, participants, production capacity, and equipment) determine ‘potential production,’ modeled using a Cobb-Douglas formulation. [Sterman, 1981] Potential production is modified by desired production and a capacity utilization effect to determine ‘scheduled production.’ The total scheduled production is then split (‘fraction nefarious’) into benign and nefarious production pipelines, set by a leadership input (‘ind[icated] fraction for nefarious production’). Two stocks (rectangles), ‘nefarious FGI⁵’ and ‘benign FGI,’ represent the end result of production activity. Overall production in this module is treated at an aggregate level; however, there exists rich opportunities to link production inputs into different models (utilizing different methodologies, when appropriate) that could model specific production lines at a higher resolution.

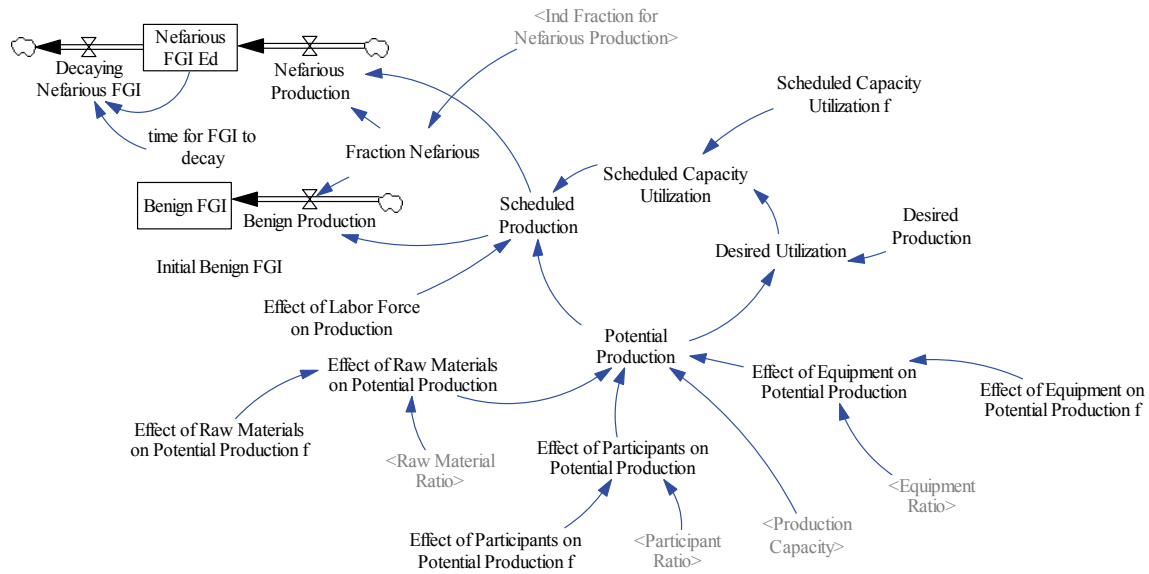

Figure 3. Causal Framework for Nefarious Activities

The leadership decision-making subsection is shown in Figure 4. The overarching logic is that changes in inputs to leadership decision making will move leadership towards or away from nefarious intentions. The top half of the sub-section combines four inputs into leadership decision making: a) threat perception; b) leadership consolidation; c) pathway

⁵ Finished Goods Inventory, terminology commonly used to represent stocks in system dynamics modeling.

progress; and d) external effects (sanctions). The effects are multiplicative and each effect is modeled using non-linear functions. The lower section of the figure calculates how relative changes in the four leadership inputs function to update leadership's decisions about nefarious production. For example, the higher the threat perception, the more likely the leadership will be to pursue nefarious production, all else equal.

Preferences for nefarious production are modeled using an anchor-and-adjustment structure. Anchoring is a cognitive bias that describes the tendency to rely on an "anchor" to one trait or piece of information when making decisions, and then adjust it to account for new factors or pressures (Tversky & Kahneman, 1974). In the model section below, the anchor is represented by the preference for nefarious development 'underlying percentage for nefarious production.' This anchor is then adjusted over time for changes in the other leadership inputs.

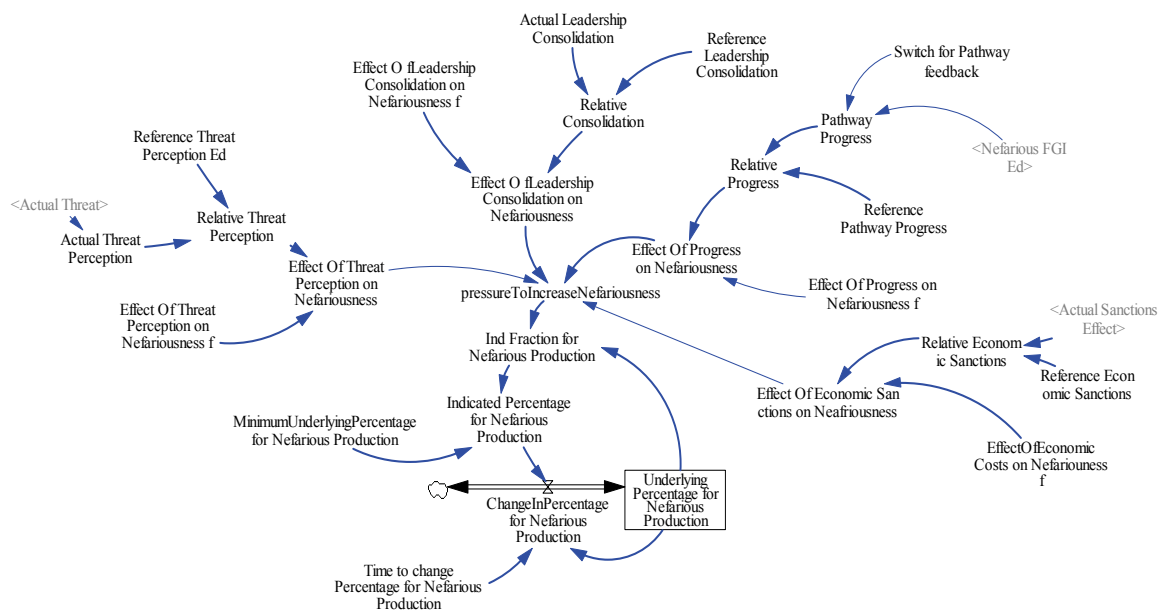

Figure 4. Leadership Inputs

The leadership module is also a rich area for extensions into other modeling methodologies. For example, other leadership models (utilizing agent-based modeling, for example) could provide inputs for changes in the four leadership inputs.

External effects on the overall system are shown in Figure 5. The overarching logic represented is how external actors perceive potential nefarious threats and take action in response. The left side of the figure serves to calculate an external 'perceived nefariousness' as a function of perceived participation and perceived production. The bottom right side of the figure functions as a sanctions effect ('indicated desired sanctions'), by which external actors respond to increases in perceived nefarious activity. The top right side represents the leadership's response to sanctions; if sanctions are active, the internal regime perceives a greater external threat ('actual threat') which is incorporated into their decision making (as shown in Figure 4 above.)

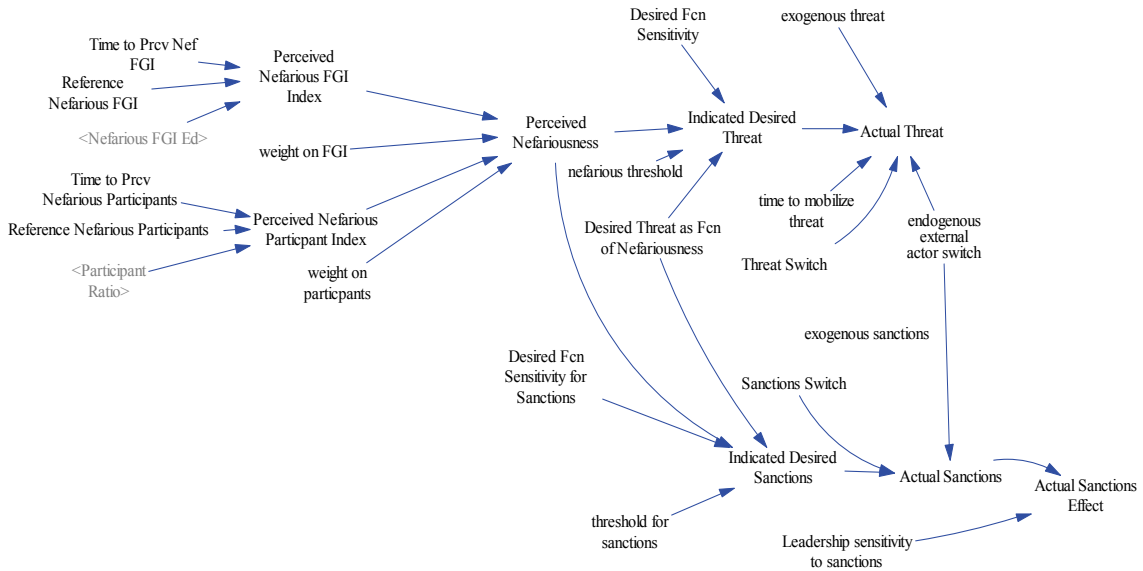

Figure 5. External Inputs

Resource inputs are the final subsection of the integrated system. The overarching logic is that individual resources have different dynamics that will determine resource availability or lack thereof in the production process. Section four below delves deeper into resource modeling, and we therefore show one resource specific input here as way of illustration (a full listing is found in Appendix A).

Individual resources can be modeled at different granularity, but the key here is how resource availability impacts the overall context of production, decision making, and external actions. Figure 6 introduces resource modeling and depicts the pipeline of raw materials necessary for production. The resource is modeled using a standard system dynamics formulation for updating an ordering pipeline. [Sterman, 2000] The logic is as follows: as more raw materials are used in production (‘raw materials consumption rate’), a ‘resource gap’ increases which triggers the ordering of new material (‘raw material order rate’). After an intermediate delay (‘raw materials on order’), the materials become available for further consumption. Of dynamic impact are: reordering policies, system delays, and management of inventory on order.

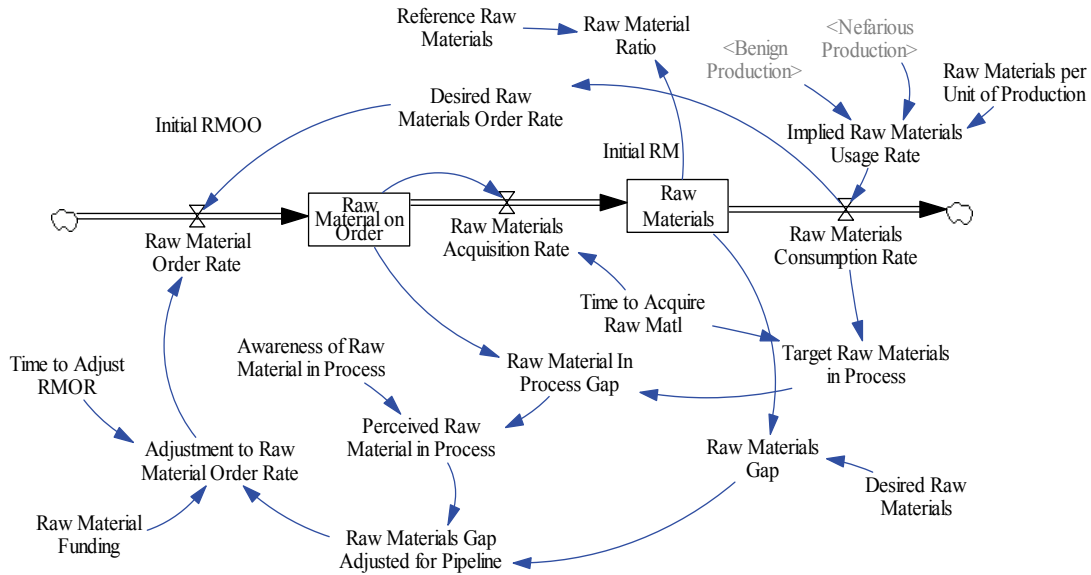

Figure 6. Resource Inputs

3.4 Simulation Analysis

We show here three sets of SDM results, namely (a) identifying and simulating probes; (b) using probe analysis to triangulate leadership preferences; and c) demonstrating potential unintended consequences. The analysis shown is to demonstrate a methodology of simulation based active intelligence; it demonstrates a proof-of-concept for using simulation analysis, which is produced using a model parameterized to notional but plausible values.

3.4.1 Simulation Analysis to Identify Probes and Create Diagnostic Effects

We show here several sets of SDM results from simulating the integrated model. The first simulation set in Figure 7 depicts a process by which probe candidates are developed. On the bottom of the figure are three resource inputs: materials, people, and equipment. The three resource inputs combine to allow an overall level of production, shown on top. The x axis is time, measured in weeks, and the y axis (without scale for demonstration purposes) is in number of units. The graph on the top shows overall production given the

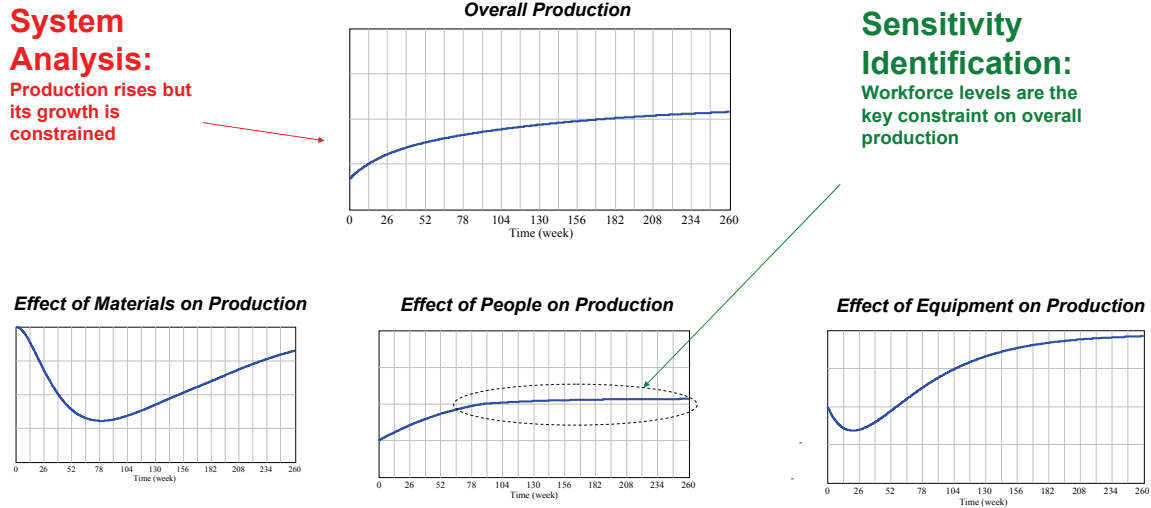

Figure 7. Developing probe candidates

total resource context. The simulation output was parameterized with the help of subject matter experts (SMEs), and the resource behavior observed is the result of the dynamic production system. For example, the initial stock of materials is used for production but replenished overtime to avoid production stops. As noted by “system analysis” in Figure 7, overall production is constrained, and as noted by “sensitivity identification,” the key resource constraint is people. For this scenario, simulation analysis has helped identify “human resources” as a good probe area, as probes to other areas would not affect the key constraint and would therefore cause lower magnitude effects to the overall system.

The next set of simulations depicts the results of a probe targeted at human resources, such as hiring away key personnel (Figure 8). An assumption is made that the benign production rate is observable. The probe is then run on two models: one in which only a benign program is active and one in which both benign and nefarious programs are active. Another assumption is made that nefarious production would take precedence over benign production, given constraints, in the nefarious model.

The base case, without a probe, is shown with a solid line. The benign model is shown with a long dashed line, and the nefarious model is shown with a short dashed line. The effect of the event lowers production in the benign case. But if a nefarious program is active, then benign development is lowered even further, as scarce resources must be pulled out of benign production to maintain the same level of nefarious production. The difference in observable production provides a clear and measurable signature of a nefarious production.

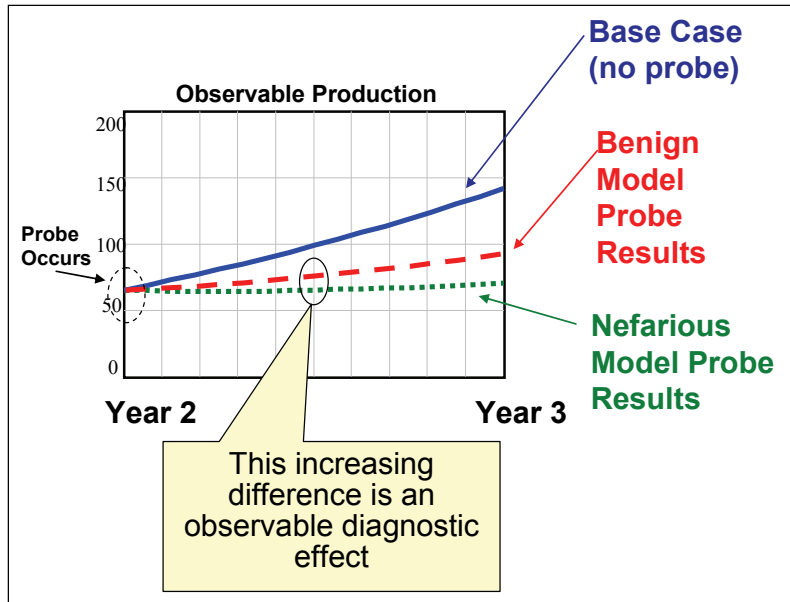

Figure 8. Probe Results

3.4.2 Simulation Analysis to Identify Leadership Characteristics

The analysis in the section below builds on the information collected via probes in the case above. The base case in Figure 9 is parameterized using information gathered from the previous probe as shown in Figure 8, which suggests the existence and potential level of nefarious production. To build on this probe, an assumption is made that a key system question concerns leadership characteristics, namely how consolidated the leadership is around pursuing nefarious production. A probe is designed to initiate a set of sanctions, with the desired effect of reducing nefarious development.

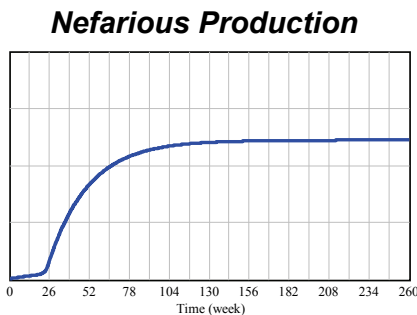
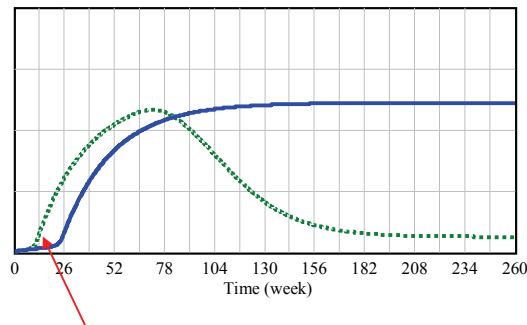

Figure 9. Base Case

Low consolidation case. The results of the probe under a certain set of leadership characteristics (specifically, a low degree on consolidation) are shown in Figure 10 using a short-dashed line. The probe is effective over time at reducing nefarious production, as low consolidation and the probe causes preferences to move away from nefariousness.

Nefarious Production



**Probe
(economic sanctions)**

Figure 10. Probe Results with Low Leadership Consolidation

High consolidation case. Figure 11 adds an additional case, one with high degrees of leadership consolidation (shown in the long-dashed line.) In this case, the probe does not result in the intended or expected results; instead it creates an oscillating pattern of development. This analysis pinpoints a need for higher fidelity intelligence on leadership consolidation, as critical signals information can look the same in the short term.

Nefarious Production

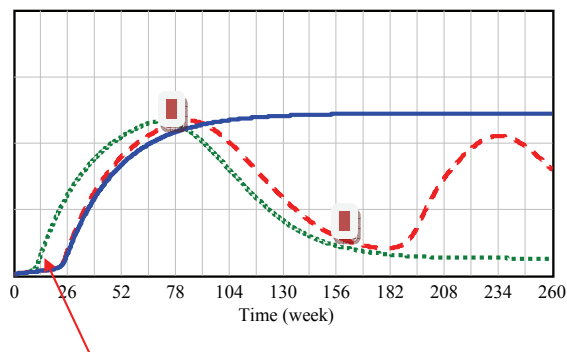

**Probe
(economic sanctions)**

Figure 11. Probe Results Showing Both Low and High Leadership Consolidation

Unintended consequence. One unintended consequence of the probe case shown in Figure 11 is the potential for mistaken analysis. Given a limited set of observables, such as just the values shown by the two points highlighted in Figure 11 and depicted in Figure 12. Without the SDM simulation analysis, a likely conclusion drawn is that production is declining (by extrapolating the data points on the left side of Figure 12). However, given the context provided by the simulation analysis, this is actually shown to be part of a larger pattern of behavior, in which production is actually falling and then rising (right side of Figure 12).

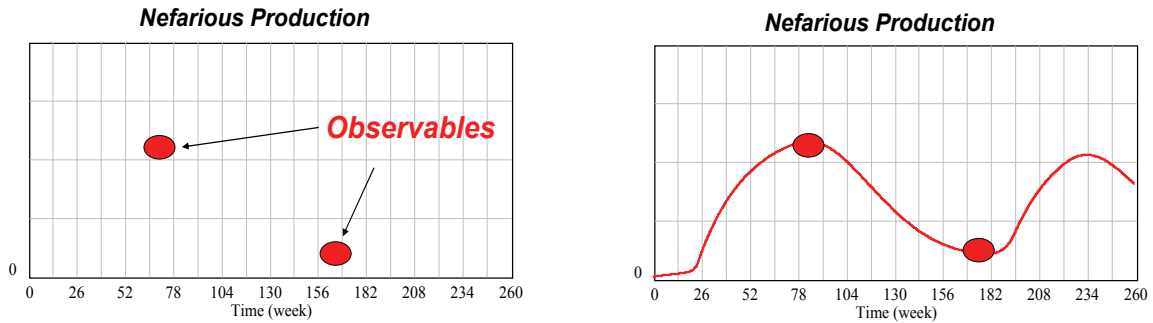

Figure 12. Observable Data With and Without Simulation Analysis

This simulation highlights the need for a system-wide perspective in which new information can be placed in context.

3.4.3 Summary of Results

The complete results and probe methodology demonstrated above are summarized in Figure 13. The figure depicts three main stages: developing probe candidates, running probes to develop intelligence, and actively probing to shape development.

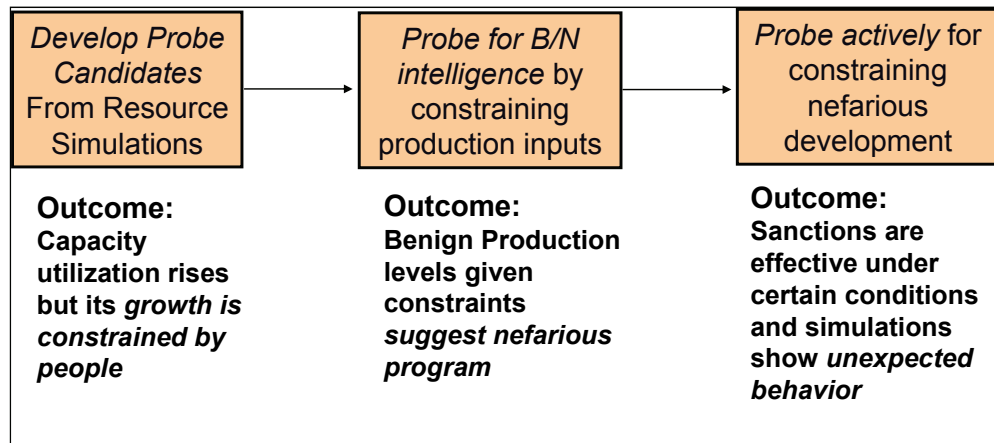

Figure 13. Summary of Probe Methodology and Results

In summation, we have (a) demonstrated a fully integrated system dynamics model derived from theory to test multiple hypothesizes concerning technology development; (b) provided simulations that support an overarching probe strategy, consisting of sequential probes, to iteratively improve system intelligence; and (c) identified “hooks” for integration with multiple models, specifically leadership and alternative fidelity pathway models.

4. Modeling Resources as Part of an Integrated Multi-Methodology System

An additional line of research was conducted into modeling resource dynamics as part of an integrated multi-methodology approach. The focus of this was to integrate multiple modeling approaches to develop active probes that determine the direction of technology development at a target organization. In particular, the case concerned the development of a vaccine that could entail both benign and nefarious applications. The basic integration structure is shown in Figure 14.⁶ Key components include: a social network model that would address high-level leadership and decision-makers; a decision model that would represent management level decisions; discrete event simulation models that would represent various stages in the pathway of research and development; a resource model that would represent critical assets in the development process, controlled by different organizations; and a backplane that would serve as a data exchange among the different models.

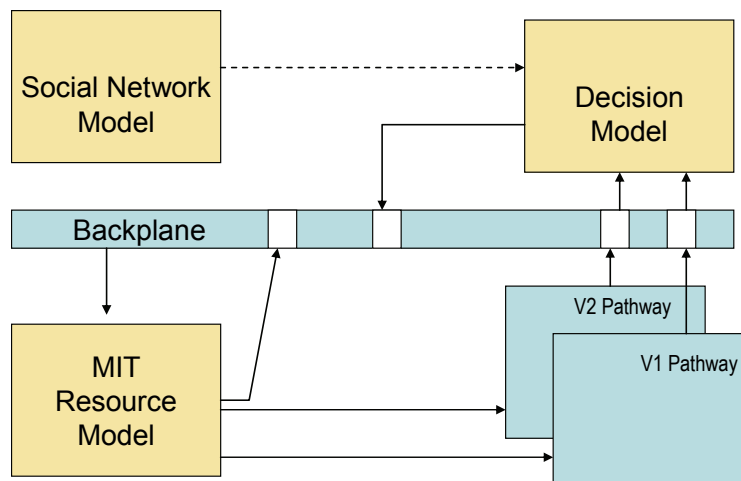

Figure 14. Simple Integration Structure

The resource model, built utilizing the system dynamics methodology, was designed with four main objectives: (a) identify and model resource dynamics across multiple organizations; (b) analyze how resource probes create meaningful system changes and produce high diagnostic value; (c) anticipate intended/unintended consequences from probes; and (d) allow for meaningful interaction with other modeling methodologies.

Specifically, the modeling provided resource levels and quality for four main resource groups: human (people, skill level), operating (physical infrastructure, equipment), materials (production inputs), and financial (available capital, funding sources). It also allowed for interactions with both the pathway and decision models: resource levels and availability would be passed to the pathway model, which would return resource usage, and resource shortfalls would be passed to the decision models, which would return

⁶ Adapted from an internal memo. The basic underlying integration structure is shown in the figure, though not all methodologies involved in the project are shown.

decisions on resource management or acquisition policy. Probe candidates generated include imposing resource limitations and disrupting supply chains. A drill down schematic of the resource area is found in Figure 15. The two-way interactions with decision and pathway models are labeled with arrows. Also depicted in the dashed box are three outside suppliers of materials, which we model separately, that provide materials input for the target organization.

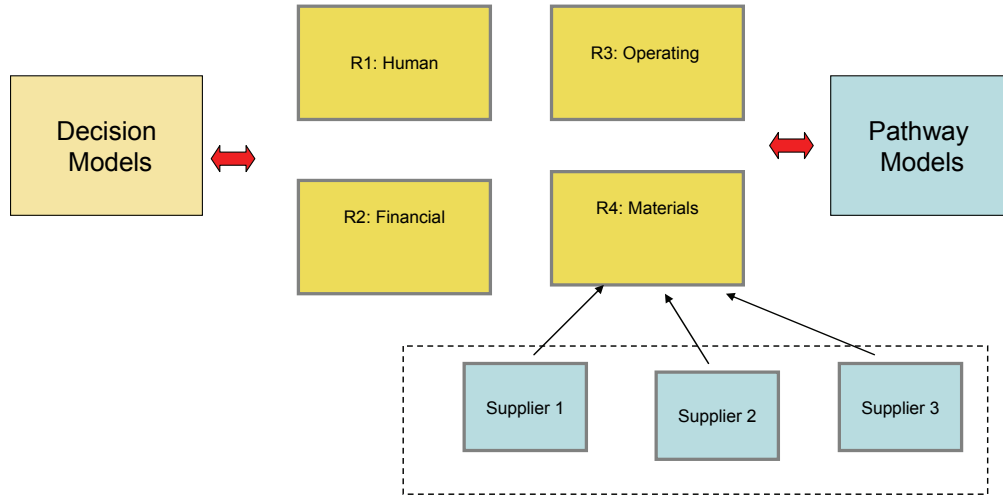

Figure 15. Resource Model Overview

A sample probe narrative is shown in Figure 16.

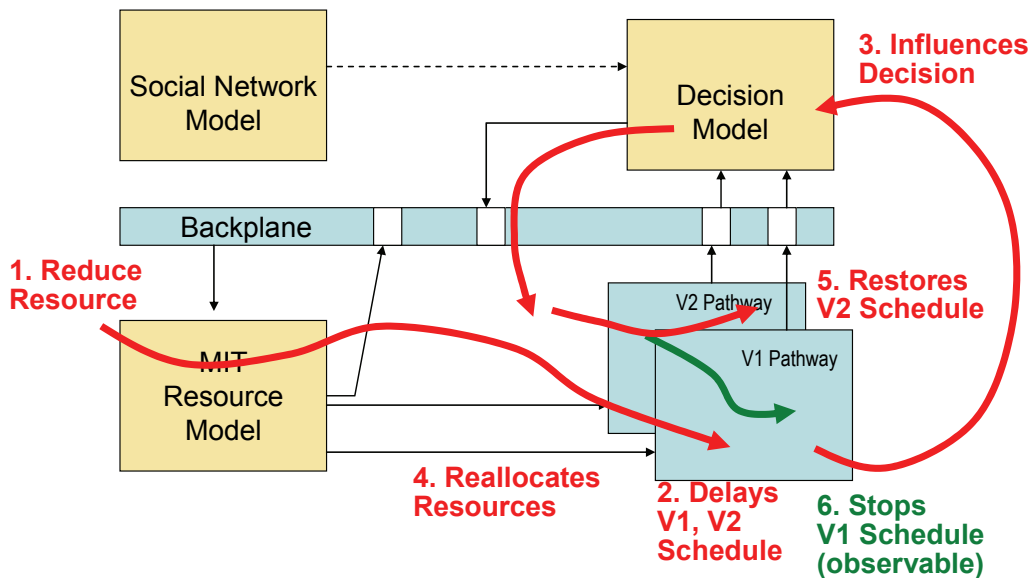

Figure 16. Sample Probe Narrative

1. Resources are constrained by a simulated probe (for example, hiring employees away from the target organization);
2. Delays are created in the various pathways, V1(benign) and V2(nefarious);

3. The decision model observes and responds to these constraints;
4. A decision is made to reallocate the scarce resource away from V1(benign) towards V2(nefarious);
5. The pathway model tracks the restoration on the V2(nefarious); and
6. The stoppage/reduction in V1(benign) is observable, and its schedule stoppage in response to the probe indicates the existence of the V2(nefarious) line.

The narrative is also demonstrated through system dynamics simulation output in Figure 17. The solid line represents the base case (often in equilibrium on the axis) and the dashed line represents the probe case. As described in the sample narrative above, a probe increases the loss of workforce (bottom left), creating a decline in workforce and experience (middle). The leadership responds by increasing hiring (top left), though while the workforce recovers there are delays in pathway progress (far right).



Figure 17. Resource Probe Simulation Output

The simulation model structure utilized in the integrated model is discussed below. Full documentation of the resource model can be found in Appendix B.⁷ For descriptive purposes, we display one resource segment, workforce, in detail below (Figure 18). The human resource model is shown in Figure 18 and is partitioned into subsections: human resources, decision model input, and probe input. The human resources segment contains two stocks, accounting for both the quantity and quality of the workforce given changes in the workforce flows (‘hiring’ and ‘attrition’). The decision model segment contains leadership inputs, such as the desired level of workforce and the time with which to

⁷ The full model provides resource levels and quality for ten key resources across four main resource groups for the integrated system

adjust workforce. The probe section contains inputs to simulate a probe to reduce workforce ('workforce reduction').

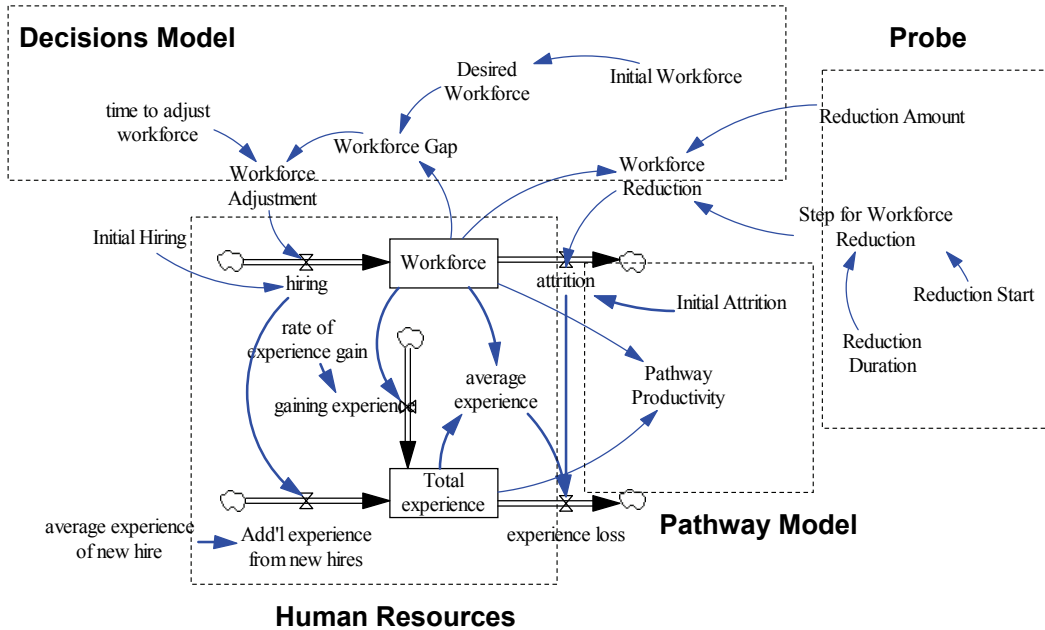

Figure 18. Illustrative Resource Structure

An additional piece of reference structure—materials suppliers—are shown in Figure 19. Three key subsections are shown: supply chain adjustment, quality adjustment, and preference. This structure represents each (we use three suppliers in the integrated system) supply chain. The logic is as follows: 'total demand' and 'preference for supply chain' (in the preference section) determine the total demand for each supplier. The supply chain adjustment section contains the allocation mechanism by which suppliers try to meet changes in demand. This section contains supplier specific characteristics, such as efficiency and speed. The quality adjustment section tracks the ongoing average quality of materials as old materials exit the system and new materials enter.

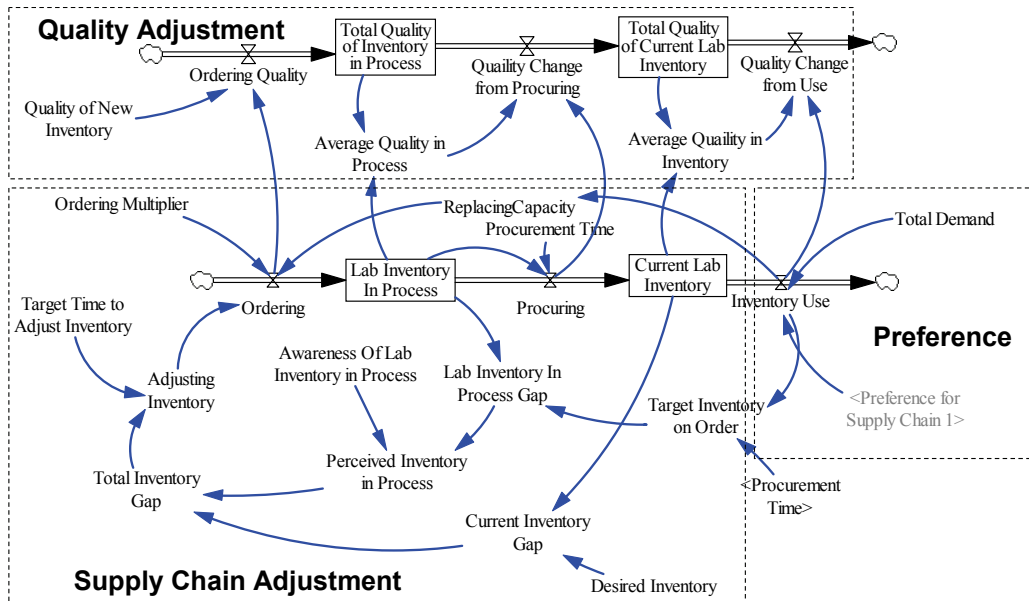

Figure 19. Supplier Model Structure

Modeling different supply chains allows for tests concerning the vulnerability of each supplier and helps identify likely probe candidates. In Figure 20, the results of a probe executed on the three supply chains are shown.

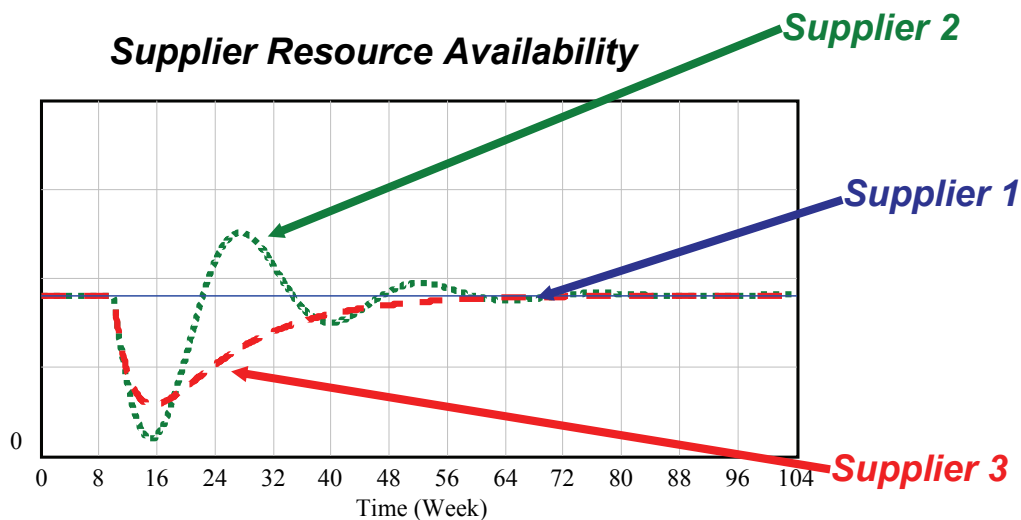

Figure 20. Supplier Vulnerability

Differences in supply chains are modeled by varying the supplier's average fulfillment delay and their efficiency in managing supply chain buffers. A less vulnerable supplier would be able to quickly and smoothly adjust their available inventory to variations in ordering, while a vulnerable supplier would be unable to manage changes in ordering and would create oscillations throughout the supply chain.

Supply chain analysis supports probe identification: while supplier one is resilient to supply chain disruptions, suppliers two and three show vulnerabilities. Further, while

supplier three is able to recover smoothly from disruption, supplier two begins to oscillate, likely creating greater downstream disruptions. Therefore, given the three different suppliers, a probe aimed at supplier three will likely have the most meaningful impact on the pathway model.

5. Formalizing Pro-Active Intelligence Probes

Up to this point we have informally defined active intelligence probes as an action or stimulus designed to produce system behaviors (active probe) or to collect data. In this section, we introduce the basics of a more formalized definition and notation of intelligence probes that may serve as a potential roadmap for future investigations into probes.

Specifically, a probe is defined as an act or set of acts that are initiated starting at some time ‘t’ with the goal to directly affect one or more measurable system attributes over some time period. The effect of the probe is to change measurable system attributes for the purpose of achieving a desired outcome. A desired outcome may be to gain useful information or to move the system in a preferred direction (active probe).

Formally, $P_1(\{x_i\}, t, \{y_k\})$ is defined as a Probe P_1 to affect one or more system attributes, $\{x_1, x_2, \dots, x_m\}$ ($= \{x_i\}$), starting at time t , with the purpose of a desired outcome on one or more system attributes $\{y_1, y_2, \dots, y_n\}$ ($= \{y_k\}$) (where a given y_k may or may not be the same as some x_i).

Additional definitions:

- $P_1(t_1)$ - simplified from $P_1(\{x_i\}, t, \{y_k\})$
- $S_1(\{P_1(t_1), P_2(t_2), \dots\}, t_n)$ – a strategy plan S_1 as planned at time t_n
- $\Delta y_I(P_1(t_1), t_n)$ – the intended change of y from probe $P_1(t_1)$ as predicted at time t_n
- $\Delta y_A(P_1(t_1), t_n)$ – the actual change in y from probe $P_1(t_1)$ as observed at time t_n
- $\Delta y_A(E_1(t_m), t_n)$ – the actual change in y from some other event as observed at time t_n

Figure 21 shows a formalized probe strategy overtime.

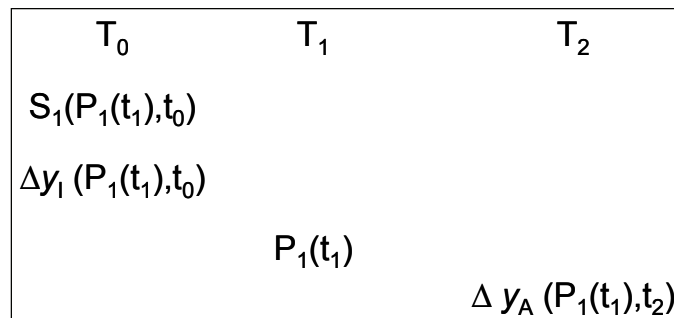

Figure 21. Formalized Probe Strategy

Further formalization of “probe theory” combined with simulation and analysis is an important step towards developing a theory of active intelligence. Together these can provide the underlying equations for representing systems and their interactions. These coupled with events and actions that are observed in the system can provide new insights into the actions of an entity and the detection of unwanted behavior.

6. Conclusion

6.1 Summary

This research effort addresses four broadly stated goals:

- (1) to develop models of the development processes of current or emergent technologies that may threaten the US;
- (2) to identify factors and strategies that may influence the evolution of these threats;
- (3) to develop methods for determining comprehensive indicators of these threats using active intelligence; and
- (4) to demonstrate how real world data and key indicators can be used to adjust models and develop model-based influence strategies.

We have demonstrated the capability of using the system dynamics modeling methodology to meet those four goals, both in stand-alone holistic models and as part of an integrated multi-methodology system.

6.2 Future Research

In the future, we see an iterative process in the development of models to support active intelligence.

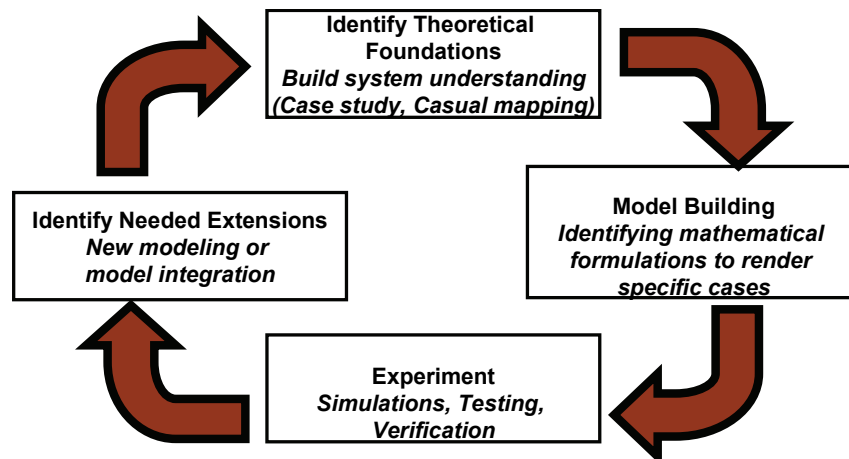

Figure 22. Overview of Methodology

The modeling approach shows an iterative system in which model advancement is developed from the dynamic interactions between models, system users, and emerging data. A typical approach, shown in (Figure 22), would be as follows:

- Develop a systems overview from literature and case studies that bounds the problem and identifies likely dynamics
- Initiate model building that structures the best current thought (including differing perspectives) and data on the system of interest
- Generate likely outcomes and testable hypothesis from model analysis (i.e. if the model is accurate, we would anticipate the following outcome, or if “x” perspective is correct, we should observe “y”.)
- Test these hypotheses with active intelligence probes, verify with naturally occurring experiments, and compare to emerging data. A naturally occurring experiment utilizes the occurrence of an observable phenomenon to approximate or duplicate the properties of a controlled experiment. These events aren’t created by design, but nonetheless yield valuable data. This process can (a) confirm model assumptions, or (b) identify new model extensions (i.e. learn) to better represent the real world
- Return to expanding system’s intelligence with new information and continue the process

Future research in this area could be based on the reasoning that simulation technologies are necessary to operate in intelligence environments that are complex, ambiguous, and data poor. Innovative simulation technologies would exploit opportunities in machine learning to iteratively discover and validate underlying “system” structure; systems could include countries, transnational networks, emerging technologies, or WMD threats. The approach would be predicated on combining modeling techniques, expert input, applicable theory, and data (as it becomes available) to triangulate likely patterns of future behavior as well as high-leverage policies to shape desired outcomes. This would lead to more rapid and accurate discovery of policy determinants and options, testable hypothesis regarding key unknowns, as well as ensure the consistency of data by embedding it in a more accurate framework.

Unlike prior technologies that have focused on machine learning to create cognitive systems that can learn and reason to structure massive amounts of raw data, innovative programs are necessary to focus on “closed systems” in which key system attributes are unknown and data is sparse, unstructured, and potentially unreliable. New technologies, such as the system dynamics methodology (SDM), can operate in these difficult environments and can combine a mix of techniques to better “learn” ground truth. New machine learning technologies would improve existing capabilities to validate SDM models by assisting to update the models themselves to reflect emerging information. Confidence would be increased in “closed systems” as SDM modeling projections and available data combine to show greater consistency over time.

Acknowledgement

We acknowledge the leadership and guidance provided by Dr. Peter Brooks, as the Program Manager for the IARPA PAINT program, and the input from Dr. Robert Popp and National Security Innovations (NSI), as sub-contractors to this effort. Work reported

herein was sponsored, in part, by the Air Force Research Laboratory, Rome, NY under contract FA8750-07-C-0101 as part of the Proactive Intelligence (PAINT) program of the Intelligence Advanced Research Projects Activity (IARPA) BAA-07-01-IFKA.

References:

- Abdel-Hamid, T. and S. E. Madnick. (1991). *Software Project Dynamics: An Integrated Approach*. Englewood Cliffs, NJ: Prentice Hall.
- Allison, G.T. (1969). "Conceptual models and the Cuban missile crisis", in Viotti, P.R., Kauppi, M.V. (Eds), *International Relations Theory: Realism, Pluralism, Globalism*, 2nd ed., Macmillan, New York, NY, 1993, pp.342-74.
- Allison, G.T. and Zelikow, P. (1999) *Essence of Decision: Explaining the Cuban Missile Crisis*. New York: Addison-Wesley Longman.
- Almond, G.A., and Powell, G.B. (1966) *Comparative Politics: a Developmental Approach*. Boston: Little, Brown.
- Angerhofer, B., and M. Angelides. (2000). "System Dynamic Modeling in Supply Chain Management: Research Review." *Proceedings of the 2000 Winter Simulation Conference*, J. A. Joines, R.R. Barton, K. Kang, and P.A. Fishwick, eds. Available online: <http://64.233.161.104/search?q=cache:5-p--kFpsZMJ:www.informssim.org/wsc00papers/049.PDF+Angerhofer+and+angelides&hl=en> (Accessed November 27, 2005).
- Choucri, N. (1981). *International Energy Futures : Petroleum Prices, Power, and Payments*. Cambridge, MA : MIT Press.
- Choucri, N. and M. Bousefield (1978). "Alternative Futures: An Exercise in Forecasting," in Choucri, N. and T. W. Robinson, eds., *Forecasting in International Relations*. Cambridge, MA. San Francisco: W. H. Freeman and Co.: 308-326.
- Choucri, N. Electris, C. Goldsmith, D. Mistree, D. Madnick, S.E. Morrison, J.B. Siegel, M.D. Sweitzer-Hamilton, M "Understanding and Modeling State Stability: Exploiting System Dynamic," *IEEE Aerospace Conference*, 2006.
- Choucri, N., Goldsmith, D., Mistree, D., Madnick, S.E. , Morrison, J.B., Siegel, M.D., "Using System Dynamics to Model and Better Understand State Stability," *Proceedings of the International Conference of the System Dynamics Society*, July 2007.
- Forrester, J. W. (1958) "Industrial Dynamics--A Major Breakthrough for Decision Makers." *Harvard Business Review*, 36(4), 37-66.
- Forrester, J. W. (1980). *Principles of Systems, 2nd Preliminary Edition*. Cambridge, MA: MIT Press.
- Forrester, J. W. (1991). "System Dynamics and the Lessons of 35 Years," in *The Systemic Basis of Policy Making in the 1990s*, Kenyon B De Greene, ed. Available online: <http://www.echelon4.com/content%20files/forrester%20d4224.pdf> (Accessed November 27, 2005).
- Holsti, O.R. (1962) "The Belief System and National Images: A Case Study," *The Journal of Conflict Resolution*, Vol 7, 244-252

- Holsti, O.R. (1972) *Crisis, Escalation, War*. Montreal and London: McGill-Queen's University Press.
- Jervis, Robert (1970). *The Logic of Images*. Princeton, NJ: Princeton University Press.
- Jervis, Robert (1997). *System Effects: Complexity in Political and Social Life*. Princeton, NJ: Princeton University Press.
- Lofdahl, C. L. (2002). *Environmental Impacts of Globalization and Trade: A Systems Study*. Cambridge, MA: MIT Press.
- Lofdahl, C. L. (2005). "Envisioning C2 Systems Through Simulation: An Air Force Example." *Presented at the 10th International Command and Control Research Symposium: The Future of C2*. Available online: <http://www.dodccrp.org/events/2005/10th/CD/papers/219.pdf> (Accessed November 27, 2005).
- North, R. C. (1990). *War, Peace, Survival: Global Politics and Conceptual Synthesis*. Boulder: Westview Press.
- Office of the Under Secretary of Defense for Acquisitions, Technology, and Logistics. *Report of the Joint Defense Science Board Intelligence Science Board Task Force on Integrating Sensor-Collected Intelligence*. November, 2008.
- Robbins, M. (2005). "Investigating the Complexities of Nationbuilding: A Sub-National Regional Perspective." In partial fulfillment of a Master of Science, Air Force Institute of Technology.
- Schelling, T. (1963). *The Strategy of Conflict*. Londong: Oxford University Press.
- Singh, S. and Way, C. (2004) "The Correlates of Nuclear Proliferation: A Quantitative Test." *The Journal of Conflict Resolution*, 48(6), 859-885.
- Sterman, J. (2000) *Business Dynamics: System Thinking and Modeling for a Complex World*. Irwin/McGraw-Hill.
- Sterman, J. D. (1981). *The Energy Transition and the Economy: A System Dynamics Approach*. In partial fulfillment of a Doctorate of Philosophy, Sloan School of Management, Massachusetts Institute of Technology.
- Sterman, John. *The Effect of Depletion on Economic Growth*. MIT Doctoral Thesis. 1980.
- Tversky, A., & Kahneman, D. (1974). "Judgment under uncertainty: heuristics and biases." *Science*, 185, 1124–1131.

Appendix A: Full Simulation Model Equations

Nefarious FGI Full Effect =IF THEN ELSE (FGI Fractional Gap<0.2,FGI Fractional Gap^(1/5),1)
 Threshold for sanctions=0.05
 Actual Sanctions=IF THEN ELSE(endogenous external actor switch=1,Indicated Desired Sanctions* Sanctions Switch,0)
 Actual Sanctions Effect=smoothi(Actual Sanctions,Leadership sensitivity to sanctions,0)
 Actual Threat= IF THEN ELSE(endogenous external actor switch=1,smooth(Indicated Desired Threat,time to mobilize threat)*Threat Switch,exogenous threat)
 Actual Threat Perception=Actual Threat
 endogenous external actor switch= Desired Fcn
 Sensitivity for Sanctions=1
 exogenous sanctions= 0.5
 exogenous threat=.5
 time to mobilize threat= 2
 time for FGI to decay= 26
 Decaying Nefarious FGI=Nefarious FGI Ed/time for FGI to decay
 Sanctions Switch= 1
 Leadership sensitivity to sanctions= 26
 Indicated Desired Sanctions= Desired Threat as Fcn of Nefariousness(Perceived Nefariousness/threshold for sanctions)^{Desired Fcn Sensitivity for Sanctions}
 FGI Fractional Gap= Max(0,(max nefarious FGI-Nefarious FGI Ed)/max nefarious FGI)
 Initial Nefarious FGI= 100
 max nefarious FGI= 50000
 Threat Switch= 1
 Nefarious FGI Ed= INTEG (Nefarious Production-Decaying Nefarious FGI,Initial Nefarious FGI)
 Nefarious Participants= INTEG (Mobilizing Nefarious Participants-Demobilizing Nefarious Participants,0)
 Mobilizing Nefarious Participants=Nefarious Participant Gap/Avg Time to Mobilize Nefarious Participants
 nefarious threshold= 0.2
 Reference Nefarious FGI= 10000
 Reference Nefarious Participants= 1
 Indicated Desired Threat= Desired Threat as Fcn of Nefariousness(Perceived Nefariousness/nefurious threshold)^{Desired Fcn Sensitivity}
 Desired Threat as Fcn of Nefariousness([(0,0)-(2,1)],(0,0),(0.25,0.01),(0.5,0.05),(0.67,0.125),(0.8,0.25),(1,0.5),(1.2,0.75),(1.33,0.885),(1.5,0.95),(1.75,0.99),(2,1))
 Desired Fcn Sensitivity=1
 Nefarious Participant Gap= Desired Nefarious Participants-Nefarious Participants
 Perceived Nefarious FGI Index=smoothi(Nefarious FGI Ed/Reference Nefarious FGI,Time to Prev Nef FGI,0)

Perceived Nefarious Participant Index=smoothi(Participant Ratio/Reference Nefarious Participants,Time to Prcv Nefarious Participants,0)
 Perceived Nefariousness=Max(Perceived Nefarious FGI Index,weight on FGI*Perceived Nefarious FGI Index+weight on participants *Perceived Nefarious Participant Index)
 Time to Prcv Nef FGI=4
 Time to Prcv Nefarious Participants=26
 Total Participants=Active Participants+Nefarious Participants
 weight on participants=0.2
 weight on FGI=0.5
 Demobilizing Nefarious Participants=(Nefarious Participants/Avg Time to Demobilize Nefarious Participants)*Switch for Demobilizing Nefarious Participants
 Initial PE= INITIAL(Desired Equipment)
 Actual Leadership Consolidation= 1000
 Switch for Pathway feedback=1
 Effect Of Progress on Nefariousness=Effect Of Progress on Nefariousness f (Relative Progress)
 Relative Progress=Pathway Progress / Reference Pathway Progress
 Pathway Progress=(Nefarious FGI Ed*Switch for Pathway feedback)+((1-Switch for Pathway feedback)*10)
 Effect Of Progress on Nefariousness f([(0,0)(2,2)],(0,0),(0.25,0.35),(0.5,0.65), (0.75,0.85),(1,1), (1.25,1.1),(1.5,1.18)
 MinimumUnderlyingPercentage for Nefarious Production= 0.1
 pressureToIncreaseNefariousness= Effect O fLeadership Consolidation on Nefariousness*Effect Of Progress on Nefariousness *Effect Of Economic Sanctions on Neafriousness*Effect Of Threat Perception on Nefariousness
 Fraction Nefarious=Ind Fraction for Nefarious Production*Nefarious FGI Full Effect
 Reference Economic Sanctions=0.5
 Reference Leadership Consolidation=10
 Effect Of Threat Perception on Nefariousness=Effect Of Threat Perception on Nefariousness f (Relative Threat Perception)
 Effect Of Threat Perception on Nefariousness ([(0,0)(6,4)],(0,0.5),(0.5,0.6),(0.75,0.75) ,(0.9,0.9) ,(1,1),(1.2,1.2),(1.5,1.5),(2.20183,2.10526), (3,2.5),(3.87156,2.78947),(5,3),(6,3))
 EffectOfEconomic Costs on Nefariouness
 f([(0,0)(4,4)],(0,2),(0.423529,1.56584),(0.649412,1.35231),(0.865882,1.13879),(1,1),(1.13882,0.882562),(1.26118,0.811388),(1.46824,0.725979),(2.34862,0.438596),(4,0))
 Reference Threat Perception Ed= 0.1
 Relative Consolidation = Actual Leadership Consolidation / Reference Leadership Consolidation
 Relative Economic Sanctions=Actual Sanctions Effect / Reference Economic Sanctions
 Relative Threat Perception = Actual Threat Perception / Reference Threat Perception Ed
 ChangeInPercentage for Nefarious Production=(Indicated Percentage for Nefarious Production - Underlying Percentage for Nefarious Production) / Time to change Percentage for Nefarious Production

Ind Fraction for Nefarious Production=IF THEN ELSE((Underlying Percentage for Nefarious Production * pressureToIncreaseNefariousness<1 , (Underlying Percentage for Nefarious Production * pressureToIncreaseNefariousness\), 1)

Indicated Percentage for Nefarious Production=Max(Ind Fraction for Nefarious Production,MinimumUnderlyingPercentage for Nefarious Production)

Reference Pathway Progress = 10

Effect Of Leadership Consolidation on Nefariousness f ([(0.5,0.8)-(2,1.2)],(0.5,1.2)\,(0.648235,1.18861),(0.747059,1.16726),(0.895294,1.08897),(1,1),(1.18471,0.898221)\,(1.42118,0.835587),(1.64353,0.814235),(2,0.8))

Effect Of Economic Sanctions on Neafriousness= EffectOfEconomic Costs on Nefariouness f (Relative Economic Sanctions)/2

Underlying Percentage for Nefarious Production= INTEG (ChangeInPercentage for Nefarious Production, 0.1)

Effect Of Leadership Consolidation on Nefariousness = Effect Of Leadership Consolidation on Nefariousness f(Relative Consolidation)

Time to change Percentage for Nefarious Production = 3

Active Participants= INTEG (Demobilizing Nefarious Participants+Participant Acquisition Rate-Mobilizing Nefarious Participants\,Initial AP)

Initial RMOO= INITIAL(Target Raw Materials in Process)

DC Height= 0

DC Time= 0

Initial PC= INITIAL(Initial Desired Capacity)

Desired Capacity= Initial Desired Capacity*(1+Test Input Desired Capacity)

Initial AP= INITIAL(Desired Participants)

Initial Desired Capacity= 1000

Initial ES= INITIAL(Target Equipment Capacity in Process)

Initial PCS= INITIAL(Target Production Capacity in Process)

Initial PIT= INITIAL(Target Participants in Process)

Initial RM= INITIAL(Desired Raw Materials)

Test Input Desired Capacity= STEP(DC Height , DC Time)

Adding Potential Participants= Max((Adjustment to Participant Order Rate+Desired Participant Addition Rate),0)

Adjustment to Equipment Order Rate= (Equipment Gap Adjusted for Pipeline/Time to Adjust EOR)*Equipment Funding

Adjustment to Participant Order Rate= (Participant Gap Adjusted for Pipeline/Time to Adjust POR)*Participant Funding

Raw Materials Acquisition Rate= Raw Material on Order/Time to Acquire Raw Matl

Adjustment to Raw Material Order Rate= (Raw Materials Gap Adjusted for Pipeline/Time to Adjust RMOR)*Raw Material Funding

Average Lifespan of Equipment= 52

Participant Funding= 1

Avg Time to Demobilize Nefarious Participants= 52

Avg Time to Mobilize Nefarious Participants= 52

Awareness of Equipment in Process= 1

Awareness of Participants in Process= 1

Participants in Training= INTEG (Adding Potential Participants-Participant
 Acquisition Rate, Initial PIT)
 Awareness of Raw Material in Process= 1
 Perceived Participants in Process= Participants in Process Gap*Awareness of
 Participants in Process
 Equipment Ratio= Productive Equipment/Reference Equipment
 Perceived Raw Material in Process= Raw Material In Process Gap*Awareness of Raw
 Material in Process
 Desired Equipment= 1000
 Desired Equipment Order Rate= Retiring Equipment
 Desired Nefarious Participants= 0
 Desired Participant Addition Rate= Mobilizing Nefarious Participants
 Desired Participants= 1000
 Time to Adjust EOR= 52
 Desired Raw Materials= 1000
 Desired Raw Materials Order Rate= Raw Materials Consumption Rate
 Raw Material In Process Gap= (Target Raw Materials in Process-Raw Material on
 Order)
 Effect of Equipment on Potential Production= Effect of Equipment on Potential
 Production f(Equipment Ratio)
 Effect of Equipment on Potential Production f([(0,0)-(2,1)],(0,0),(1,1),(2,1))
 Raw Material Ratio= Raw Materials/Reference Raw Materials
 Effect of Participants on Potential Production= Effect of Participants on Potential
 Production f(Participant Ratio)
 Effect of Raw Materials on Potential Production= Effect of Raw Materials on Potential
 Production f(Raw Material Ratio)
 Raw Materials Consumption Rate= Implied Raw Materials Usage Rate
 Equipment Acquisition Rate=Equipment On Order/Time to Acquire Equipment
 Time to Acquire Equipment= 52
 Equipment Funding= 1
 Equipment Gap= (Desired Equipment-Productive Equipment)
 Equipment Gap Adjusted for Pipeline= Perceived Equipment in Process+Equipment
 Gap
 Equipment in Process Gap= (Target Equipment Capacity in Process-Equipment On
 Order)
 Equipment On Order= INTEG (Equipment Order Rate-Equipment Acquisition
 Rate, Initial ES)
 Equipment Order Rate= Max((Adjustment to Equipment Order Rate+Desired
 Equipment Order Rate),0)
 Raw Material Order Rate= Max((Adjustment to Raw Material Order Rate+Desired
 Raw Materials Order Rate),0)
 Implied Raw Materials Usage Rate= (Benign Production+Nefarious Production)*Raw
 Materials per Unit of Production
 Potential Production= Production Capacity*Effect of Raw Materials on Potential
 Production*Effect of Participants on Potential Production\ *Effect of Equipment on
 Potential Production

Switch for Demobilizing Nefarious Participants= 1
 Target Participants in Process= Time to Acquire Participants*Mobilizing Nefarious
 Participants
 Initial NP= 0
 Target Raw Materials in Process= Time to Acquire Raw Matl*Raw Materials
 Consumption Rate
 Participant Gap Adjusted for Pipeline=Perceived Participants in Process+Participant Gap
 Time to Adjust POR= 52
 Raw Material on Order= INTEG (Raw Material Order Rate-Raw Materials
 Acquisition Rate, Initial RMOO)
 Participant Ratio= Total Participants/Reference Participants
 Raw Materials= INTEG (Raw Materials Acquisition Rate-Raw Materials
 Consumption Rate, Initial RM)
 Participant Acquisition Rate=Participants in Training/Time to Acquire Participants
 Time to Acquire Participants= 52
 Raw Materials Gap= (Desired Raw Materials-Raw Materials)
 Participant Gap= (Desired Participants-Active Participants)
 Raw Materials Gap Adjusted for Pipeline= Perceived Raw Material in Process+Raw
 Materials Gap
 Raw Materials per Unit of Production= 1
 Participants in Process Gap= (Target Participants in Process-Participants in Training)
 Reference Raw Materials= 1000
 Perceived Equipment in Process= Equipment in Process Gap*Awareness of
 Equipment in Process
 Retiring Equipment= Productive Equipment/Average Lifespan of Equipment
 Reference Equipment= 1000
 Productive Equipment= INTEG (Equipment Acquisition Rate-Retiring Equipment,Initial
 PE)
 Target Equipment Capacity in Process= Time to Acquire Equipment*Retiring
 Equipment
 Time to Adjust RMOR= 52
 Time to Acquire Raw Matl= 52
 Reference Participants= 1000
 Raw Material Funding= 1
 Awareness of Production Capacity= 1
 Adjustment to Production Capacity= (Production Gap Adjusted for Pipeline/Time to
 Adjust Production Capacity)*Production Funding
 Effect of Labor Force on Production= 1
 Production Funding= 1
 Effect of Participants on Potential Production f([(0,0)-(2,1)],(0,0),(1,1),(2,1))
 Effect of Raw Materials on Potential Production f([(0,0)-(2,1)],(0,0),(1,1),(2,1))
 Production Capacity= INTEG (Processing Production Capacity-Retiring Production
 Capacity, Initial PC)
 Production Gap Adjusted for Pipeline=Perceived Productoin Capacity in
 Process+Production Capacity Gap
 Time to Adjust Production Capacity= 52

Perceived Productoin Capacity in Process= Production Capacity in Process
 Gap*Awareness of Production Capacity
 roduction Capacity in Process Gap= (Target Production Capacity in Process-Production
 Capacity Starts)
 Target Production Capacity in Process=Processing PC Time*Retiring Production
 Capacity
 Production Capacity Gap=(Desired Capacity-Production Capacity)
 Nefarious Production=Scheduled Production*Fraction Nefarious
 Desired Production= 1000
 Benign Production=Scheduled Production*(1-Fraction Nefarious)
 Average Lifespan of PC=52
 Production Capacity Starts= INTEG (Starting Production Capacity-Processing
 Production Capacity, Initial PCS)
 Processing PC Time= 52
 Benign FGI= INTEG (Benign Production, Initial Benign FGI)
 Retiring Production Capacity=Production Capacity/Average Lifespan of PC
 Starting Production Capacity=Max((Adjustment to Production Capacity+Desired
 Productive Capacity Starts),0)
 Desired Productive Capacity Starts= Retiring Production Capacity
 Processing Production Capacity=Production Capacity Starts/Processing PC Time
 Desired Utilization=Desired Production/Potential Production
 Initial Benign FGI=100
 Scheduled Production=Scheduled Capacity Utilization*Potential Production*Effect of
 Labor Force on Production
 Scheduled Capacity Utilization f([(0,0) 2,2)],(0,0),(0.25,0.35),(0.5,0.65),(0.75,0.85),(1,1),
 (1.25,1.1),(1.5,1.18),(1.75,1.23),(2,1.25))
 Scheduled Capacity Utilization=Scheduled Capacity Utilization f(Desired Utilization)

Appendix B: Documentation for Resource Model in Integrated System

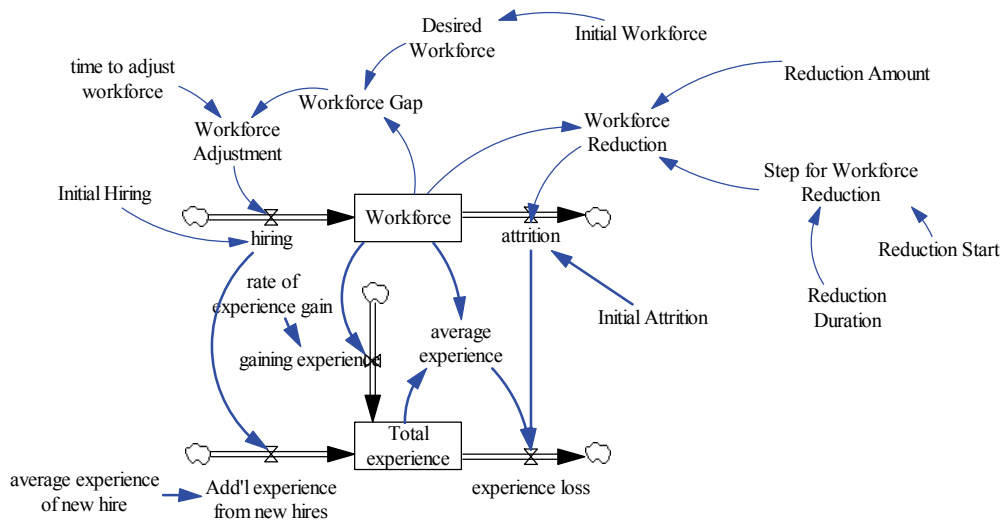

Figure B1: Workforce

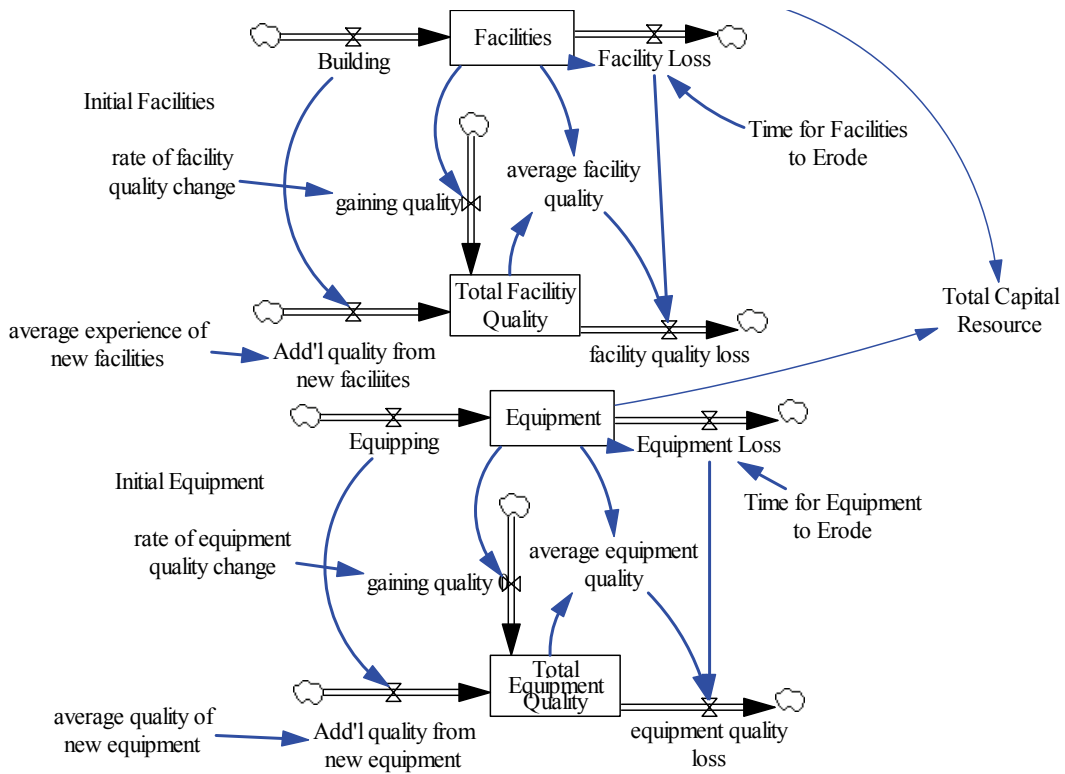

Figure B2: Facilities and Equipment

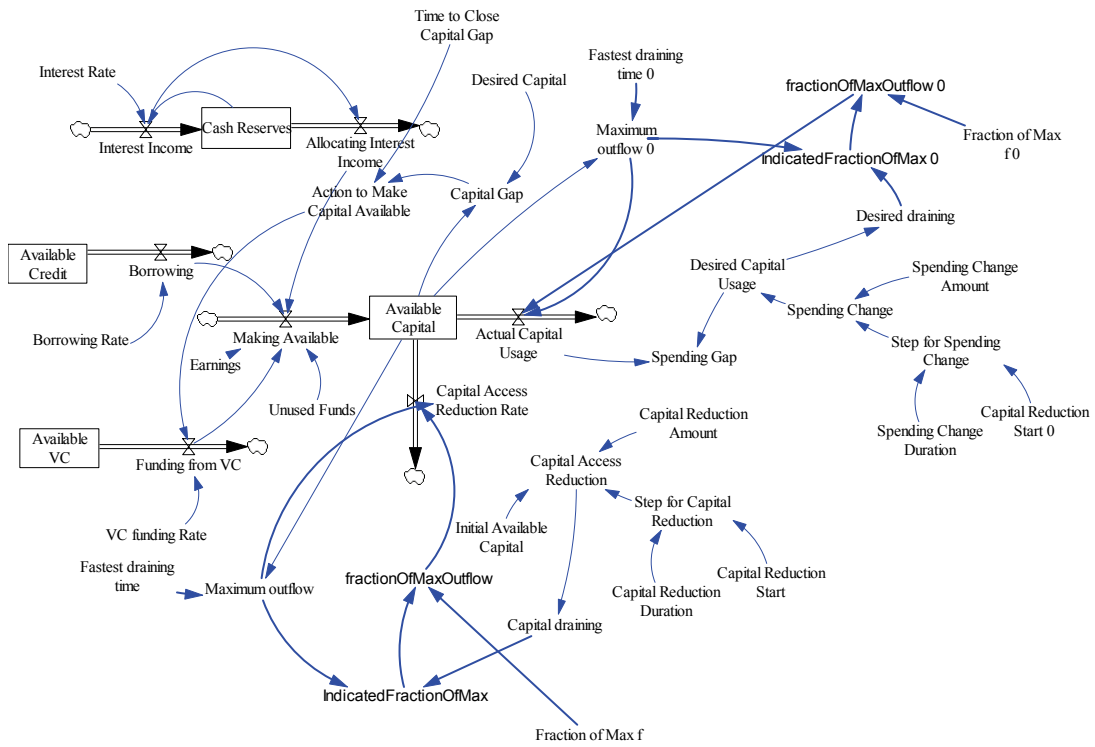

Figure B3: Financial Resources

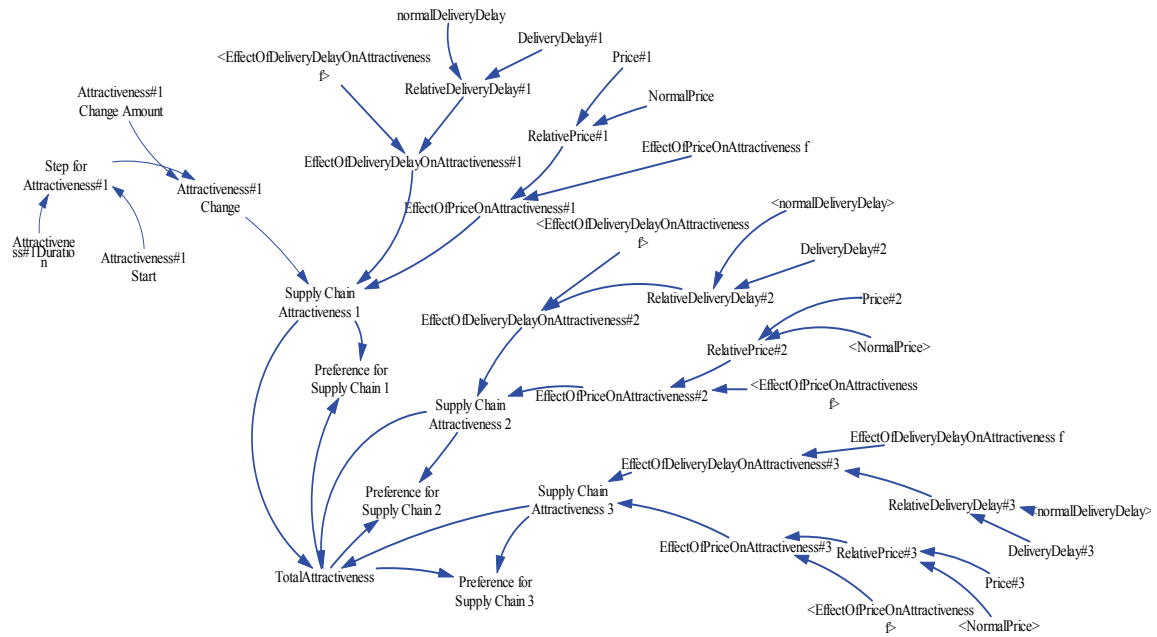

Figure B4: Supply Chain Preferences

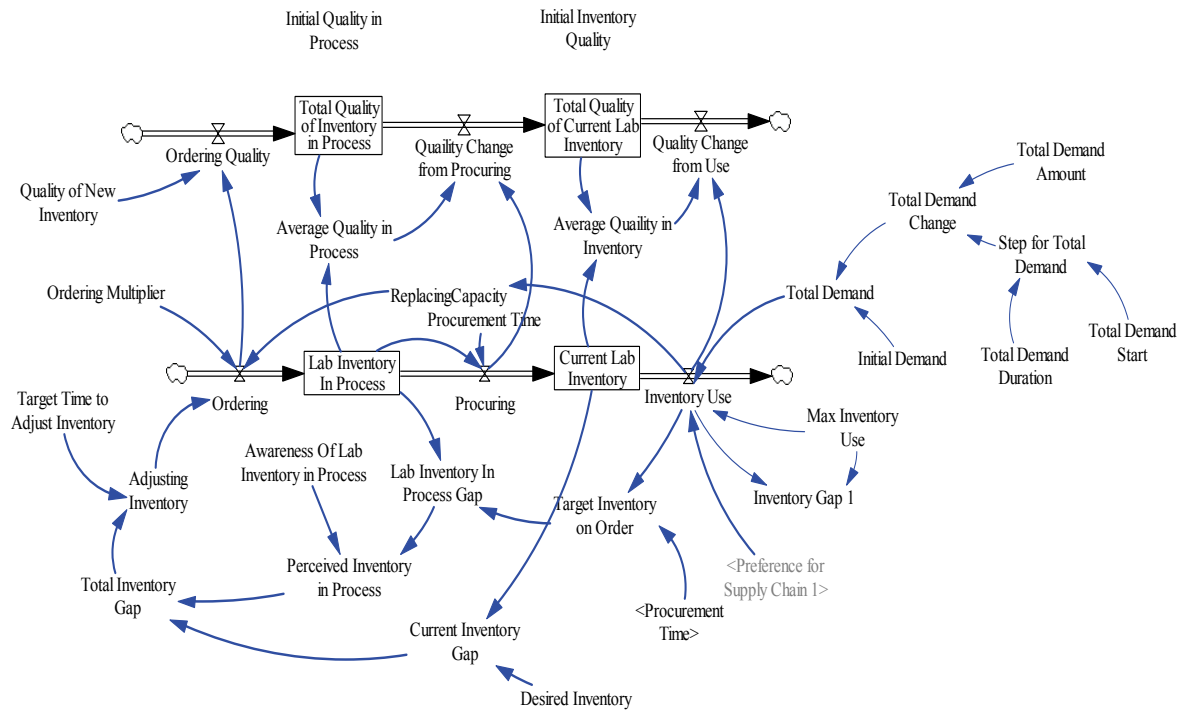

Figure B5: Raw Materials

Equations

Max Inventory Use 3= 10
 Total Demand Change= Step for Total Demand*Total Demand Amount
 Step for Total Demand= Pulse(Total Demand Start, Total Demand Duration)
 "Attractiveness#1 Change Amount"= 0
 Making Available= Allocating Interest Income+Borrowing+Earnings+Funding
 from VC+Unused Funds
 Max Inventory Use= 20
 Max Inventory Use 2= 10
 "Step for Attractiveness#1"= Pulse("Attractiveness#1 Start",
 "Attractiveness#1Duration")
 Initial Demand= 30
 Total Demand Duration= 0
 Inventory Use 3=Min(Max Inventory Use 3,(Preference for Supply Chain 3*Total
 Demand))
 "Attractiveness#1 Change"= "Step for Attractiveness#1"*"Attractiveness#1 Change
 Amount"
 "Attractiveness#1 Start"= 0
 "Attractiveness#1Duration"= 0
 Inventory Gap 1= Max Inventory Use-Inventory Use
 Total Demand= Initial Demand*(1+Total Demand Change)
 Inventory Use 2=Min(Max Inventory Use 2,(Preference for Supply Chain 2*Total
 Demand))
 Total Demand Amount= 0

Total Demand Start= 0
 Supply Chain Attractiveness 1= "EffectOfDeliveryDelayOnAttractiveness#1" *
 "EffectOfPriceOnAttractiveness#1"*(1+"Attractiveness#1 Change")
 Inventory Use= Min(Max Inventory Use,(Preference for Supply Chain
 1*Total Demand))
 Unused Funds= 0
 Fraction of Max f 0([(0,0)-
 (1.5,2),(0,0),(2,2)],(0,0),(0.5,0.5),(0.621176,0.604982),(0.72,0.683274),(0.818824\
 ,0.768683),(0.921176,0.846975),(1,0.911032),(1.11176,0.975089),(1.2,1),(1.5,1))
 Desired draining= Desired Capital Usage
 fractionOfMaxOutflow 0= Fraction of Max f 0(IndicatedFractionOfMax 0)
 Fastest draining time 0 = 0.5
 Maximum outflow 0= Available Capital/ Fastest draining time 0
 Actual Capital Usage= fractionOfMaxOutflow 0*Maximum outflow 0
 IndicatedFractionOfMax 0= xidz(Desired draining,Maximum outflow 0,10)
 Spending Gap= Desired Capital Usage-Actual Capital Usage
 Capital Reduction Start 0= 0
 Step for Spending Change= Pulse(Capital Reduction Start 0, Spending Change
 Duration)
 Spending Change Duration= 0
 Spending Change Amount= 0
 Spending Change= Step for Spending Change*Spending Change Amount
 Desired Capital Usage= 1.2e+006*(1+Spending Change)
 Capital draining= Capital Access Reduction
 IndicatedFractionOfMax= xidz(Capital draining,Maximum outflow,10)
 ~ Dmnl
 fractionOfMaxOutflow= Fraction of Max f(IndicatedFractionOfMax)
 Fastest draining time = 0.5
 Maximum outflow= Available Capital/ Fastest draining time
 Fraction of Max f([(0,0)-(1.5,2),(0,0),(2,2)],(0,0),(0.5,0.5),(0.621176,0.604982),
 (0.72,0.683274),(0.818824,0.768683),(0.921176,0.846975),(1,0.911032),(1.11176,0.9750
 89),(1.2,1),(1.5,1))
 Capital Access Reduction Rate= fractionOfMaxOutflow*Maximum outflow
 Action to Make Capital Available= Capital Gap/Time to Close Capital Gap
 Desired Capital= 4.8e+006
 Time to Close Capital Gap= 12
 Capital Gap= Desired Capital-Available Capital
 Step for Capital Reduction= Pulse(Capital Reduction Start, Capital Reduction Duration)
 Capital Access Reduction= Step for Capital Reduction*Capital Reduction
 Amount*Initial Available Capital
 Capital Reduction Amount= 0
 Available Capital= INTEG (Making Available-Capital Access Reduction Rate-Actual
 Capital Usage, Initial Available Capital)
 Capital Reduction Start= 0
 Capital Reduction Duration= 0

Initial Available Capital= 4.8e+006
 Funding from VC= VC funding Rate+Action to Make Capital Available
 Workforce Reduction= Workforce*Step for Workforce Reduction*Reduction
 Amount
 Reduction Start= 0
 Desired Workforce= Initial Workforce
 Initial Hiring= 20
 Reduction Amount= 0
 time to adjust workforce= 52
 hiring= Workforce Adjustment+Initial Hiring
 Step for Workforce Reduction= Pulse(Reduction Start, Reduction Duration)
 attrition= Initial Attrition+Workforce Reduction
 Reduction Duration= 0
 Workforce Gap= Desired Workforce-Workforce
 Workforce Adjustment= Workforce Gap/time to adjust workforce
 VC funding Rate= 300000
 Borrowing Rate= 300000
 Earnings= 300000
 Available Credit= INTEG (-Borrowing, 1e+008)
 Borrowing= Borrowing Rate
 Allocating Interest Income= Interest Income
 Cash Reserves= INTEG (Interest Income-Allocating Interest Income,
 Interest Income= Cash Reserves*Interest Rate
 Available VC= INTEG (-Funding from VC, 1e+009)
 Total Capital Resource= Equipment+Facilities
 Interest Rate= 0.03
 Add'l experience from new hires = average experience of new hire * hiring
 Add'l quality from new equipment = average quality of new equipment * Equipping
 Add'l quality from new facilities = average experience of new facilities * Building

Facility Loss = Facilities / Time for Facilities to Erode
 Building= 1800
 Time for Facilities to Erode = 10
 Initial Workforce= INITIAL(200)
 Initial Attrition= 20
 average equipment quality = Total Equipment Quality / Equipment
 average experience = Total experience / Workforce
 average experience of new facilities = 2
 average experience of new hire = 2
 average facility quality = Total Facility Quality / Facilities
 Facilities = INTEG(Building - Facility Loss, Initial Facilities)
 facility quality loss = Facility Loss * average facility quality
 gaining experience = Workforce * rate of experience gain
 gaining quality = Facilities * rate of facility quality change
 gaining quality 0 = Equipment * rate of equipment quality change
 average quality of new equipment = 2

Initial Facilities = INITIAL(Building * Time for Facilities to Erode)
 rate of equipment quality change = 1
 rate of experience gain = 1
 rate of facility quality change = 1
 Total Equipment Quality = INTEG(
 Add'l quality from new equipment + gaining quality 0 - equipment quality loss,
 Equipment * (average quality of new equipment +
 rate of equipment quality change * Equipment / Equipment Loss\
))
 Total experience= INTEG (Add'l experience from new hires + gaining experience -
 experience loss, 100)
 Time for Equipment to Erode = 10
 equipment quality loss = Equipment Loss * average equipment quality
 Equipping= 1800
 experience loss = attrition * average experience
 Workforce = INTEG(hiring - attrition, Initial Workforce)
 Total Facility Quality = INTEG(
 Add'l quality from new facilities + gaining quality - facility quality loss,
 Facilities * (average experience of new facilities +
 rate of facility quality change * Facilities / Facility Loss\
))
 Initial Equipment = INITIAL(Equipping * Time for Equipment to Erode)
 Equipment Loss = Equipment / Time for Equipment to Erode
 Equipment = INTEG(Equipping - Equipment Loss, Initial Equipment)
 Target Inventory on Order 3=
 Ordering Multiplier 2= 1
 Ordering Multiplier 3= 1
 Adjusting Inventory 2= Total Inventory Gap 2 / Target Time to Adjust Inventory 2
 Adjusting Inventory 3= Total Inventory Gap 3 / Target Time to Adjust Inventory 3
 Ordering Quality 1=Ordering 3*Quality of New Inventory 1
 Average Quality in Inventory 0= Total Quality of Current Lab Inventory 0/Current
 Lab Inventory 2
 Average Quality in Inventory 1= Total Quality of Current Lab Inventory 1/Current
 Lab Inventory 3
 Initial Inventory Quality 1= INITIAL(Current Lab Inventory 3*Quality of New
 Inventory 1)
 Average Quality in Process 0= Total Quality of Inventory in Process 0/Lab
 Inventory In Process 2
 Average Quality in Process 1= Total Quality of Inventory in Process 1/Lab
 Inventory In Process 3
 Initial Quality in Process 1= INITIAL(Quality of New Inventory 1*Lab Inventory
 In Process 3)
 Quality Change from Use 0= Average Quality in Inventory 0*Inventory Use 2
 Awareness Of Lab Inventory in Process 2 = 1
 Awareness Of Lab Inventory in Process 3 = 1
 Target Inventory on Order 2=Inventory Use 2 * Procurement Time 2

ReplacingCapacity 2 = Inventory Use 2
 Current Inventory Gap 2= Desired Inventory 2-Current Lab Inventory 2
 Current Inventory Gap 3= Desired Inventory 3-Current Lab Inventory 3
 Procurement Time 3 = 3
 Target Time to Adjust Inventory 2= 12
 Target Time to Adjust Inventory 3= 12
 Current Lab Inventory 2 = INTEG(Procuring 2 - Inventory Use 2 , Desired Inventory 2 \\
 Current Lab Inventory 3 = INTEG(Procuring 3 - Inventory Use 3 , Desired Inventory 3)
 Procuring 3 = Lab Inventory In Process 3 / Procurement Time 3
 Perceived Inventory in Process 2= Lab Inventory In Process Gap 2*Awareness Of Lab
 Inventory in Process 2
 Quaility Change from Procuring 0= Average Quality in Process 0*Procuring 2
 Quaility Change from Procuring 1= Average Quality in Process 1*Procuring 3
 Lab Inventory In Process 3 = INTEG(Ordering 3 - Procuring 3 , Target Inventory on
 Order 3\
 Total Quality of Current Lab Inventory 0= INTEG (Quaility Change from Procuring 0-
 Quality Change from Use 0, Initial Inventory Quality 0)
 Desired Inventory 2= 90
 Desired Inventory 3= 90
 Quality of New Inventory 0= 10
 Quality of New Inventory 1= 10
 Ordering Quality 0= Ordering 2*Quality of New Inventory 0
 Initial Quality in Process 0= INITIAL(Quality of New Inventory 0*Lab Inventory
 In Process 2)
 Lab Inventory In Process 2 = INTEG(Ordering 2 - Procuring 2 , Target Inventory on
 Order 2)
 Initial Inventory Quality 0= INITIAL(Current Lab Inventory 2*Quality of New
 Inventory 0)
 Lab Inventory In Process Gap 3= Target Inventory on Order 3-Lab Inventory In
 Process 3
 Ordering 2=(Adjusting Inventory 2 + ReplacingCapacity 2)*Ordering Multiplier 2
 Total Inventory Gap 3= Perceived Inventory in Process 3+Current Inventory Gap 3
 Total Quality of Inventory in Process 0= INTEG (Ordering Quality 0-Quaility Change
 from Procuring 0, Initial Quality in Process 0)
 Total Quality of Inventory in Process 1= INTEG (Ordering Quality 1-Quaility Change
 from Procuring 1, Initial Quality in Process 1)
 Total Inventory Gap 2= Perceived Inventory in Process 2+Current Inventory Gap 2
 Procurement Time 2 = 3
 Lab Inventory In Process Gap 2= Target Inventory on Order 2-Lab Inventory In
 Process 2
 Quality Change from Use 1= Average Quaility in Inventory 1*Inventory Use 3
 Perceived Inventory in Process 3= Lab Inventory In Process Gap 3*Awareness Of Lab
 Inventory in Process 3
 Ordering 3=(Adjusting Inventory 3 + ReplacingCapacity 3)*Ordering Multiplier 3
 Total Quality of Current Lab Inventory 1= INTEG (Quaility Change from Procuring 1-
 Quality Change from Use 1, Initial Inventory Quality 1)

Procuring 2 = Lab Inventory In Process 2 / Procurement Time 2
 ReplacingCapacity 3 = Inventory Use 3
 Ordering Multiplier 0= 1
 Initial Inventory Quality= INITIAL(Current Lab Inventory*Quality of New Inventory)
 Adjusting Inventory 0= Total Inventory Gap 0 / Target Time to Adjust Inventory 0
 Adjusting Inventory 1= Total Inventory Gap 1 / Target Time to Adjust Inventory 1
 Average Quality in Inventory= Total Quality of Current Lab Inventory/Current Lab Inventory
 Average Quality in Process= Total Quality of Inventory in Process/Lab Inventory In Process
 Perceived Inventory in Process 1= Lab Inventory In Process Gap 1*Awareness Of Lab Inventory in Process 1
 Awareness Of Lab Inventory in Process 0 = 1
 Awareness Of Lab Inventory in Process 1 = 1
 Preference for Supply Chain 3 = Supply Chain Attractiveness 3 / TotalAttractiveness
 Current Inventory Gap 0= Desired Inventory 0-Current Lab Inventory 0
 Current Inventory Gap 1= Desired Inventory 1-Current Lab Inventory 1
 "Price#3"= 10
 Current Lab Inventory 0 = INTEG(Procuring 0 - Inventory Use 0 , Desired Inventory 0 \ Current Lab Inventory 1 = INTEG(Procuring 1 - Inventory Use 1 , Desired Inventory 1 \ "DeliveryDelay#1"= 10
 "DeliveryDelay#2"= 10
 "DeliveryDelay#3"= 10
 Procuring 1 = Lab Inventory In Process 1 / Procurement Time 1
 Desired Inventory 0= 90
 Desired Inventory 1= 90
 EffectOfDeliveryDelayOnAttractiveness f ([(0.5,0)-(1,1)],(0.5,0.01),(0.561856,0.0263158),(0.631443,0.0690789),(0.681701,0.131579),(0.725515,0.259868),(0.780928,0.634868),(0.824742,0.828947),(0.880155,0.934211),(0.917526,0.973684),(0.962629,0.983553),(1,1))
 "EffectOfDeliveryDelayOnAttractiveness#1" = EffectOfDeliveryDelayOnAttractiveness f ("RelativeDeliveryDelay#1")
 "EffectOfDeliveryDelayOnAttractiveness#2" = EffectOfDeliveryDelayOnAttractiveness f ("RelativeDeliveryDelay#2")
 "EffectOfDeliveryDelayOnAttractiveness#3" = EffectOfDeliveryDelayOnAttractiveness f ("RelativeDeliveryDelay#3")
 EffectOfPriceOnAttractiveness f ((1,0)(2,1)],(1,1),(1.20103,0.911184),(1.33505,0.769737),(1.44845,0.430921),(1.63402,0.141447),(1.78608,0.0690789),(2,0.05))
 "EffectOfPriceOnAttractiveness#1" = EffectOfPriceOnAttractiveness f ("RelativePrice#1")
 "EffectOfPriceOnAttractiveness#2" = EffectOfPriceOnAttractiveness f ("RelativePrice#2")
 "EffectOfPriceOnAttractiveness#3" = EffectOfPriceOnAttractiveness f ("RelativePrice#3")

Initial Quality in Process= INITIAL(Quality of New Inventory*Lab Inventory In Process)
 ReplacingCapacity 0 = Inventory Use 0
 Inventory Use 0= 10
 Inventory Use 1= 10
 Supply Chain Attractiveness 2 = "EffectOfDeliveryDelayOnAttractiveness#2" * "EffectOfPriceOnAttractiveness#2"
 Lab Inventory In Process 0 = INTEG(Ordering 0 - Procuring 0 , Target Inventory on Order 0)
 Lab Inventory In Process 1 = INTEG(Ordering 1 - Procuring 1 , Target Inventory on Order 1)
 Target Inventory on Order 0=Inventory Use 0 * Procurement Time 0
 Lab Inventory In Process Gap 0= Target Inventory on Order 0-Lab Inventory In Process 0
 Lab Inventory In Process Gap 1= Target Inventory on Order 1-Lab Inventory In Process 1
 normalDeliveryDelay= 10
 NormalPrice= 10
 Quaility Change from Procuring= Average Quality in Process*Procuring
 Ordering 0= (Adjusting Inventory 0 + ReplacingCapacity 0)*Ordering Multiplier 0
 Ordering 1= (Adjusting Inventory 1 + ReplacingCapacity 1)*Ordering Multiplier 1
 TotalAttractiveness = Supply Chain Attractiveness 1 + Supply Chain Attractiveness 2 +\ Supply Chain Attractiveness 3
 Quality of New Inventory= 10
 Ordering Multiplier 1= 1
 Ordering Quality= Ordering*Quality of New Inventory
 "RelativeDeliveryDelay#3" = normalDeliveryDelay / "DeliveryDelay#3"
 Perceived Inventory in Process 0= Lab Inventory In Process Gap 0*Awareness Of Lab Inventory in Process 0
 "RelativePrice#2" = "Price#2" / NormalPrice
 Preference for Supply Chain 1 = Supply Chain Attractiveness 1 / TotalAttractiveness
 Preference for Supply Chain 2 = Supply Chain Attractiveness 2 / TotalAttractiveness
 Quality Change from Use= Average Quaility in Inventory*Inventory Use
 "Price#1"= 10
 "Price#2"= 10
 Procuring 0 = Lab Inventory In Process 0 / Procurement Time 0
 Supply Chain Attractiveness 3 = "EffectOfDeliveryDelayOnAttractiveness#3" * "EffectOfPriceOnAttractiveness#3"
 Procurement Time 0 = 3
 Procurement Time 1 = 3
 Target Inventory on Order 1=Inventory Use 1 * Procurement Time 1
 Total Quality of Inventory in Process= INTEG (Ordering Quality-Quaility Change from Procuring, Initial Quality in Process)
 Target Time to Adjust Inventory 0= 12

Target Time to Adjust Inventory 1= 12
 "RelativeDeliveryDelay#2" = "DeliveryDelay#2" / normalDeliveryDelay
 Total Quality of Current Lab Inventory= INTEG (Quality Change from Procuring-
 Quality Change from Use, Initial Inventory Quality) |
 "RelativePrice#1" = "Price#1" / NormalPrice
 "RelativeDeliveryDelay#1" = "DeliveryDelay#1" / normalDeliveryDelay
 ReplacingCapacity 1 = Inventory Use 1
 Total Inventory Gap 0= Perceived Inventory in Process 0+Current Inventory Gap 0
 "RelativePrice#3" = "Price#3" / NormalPrice
 Total Inventory Gap 1= Perceived Inventory in Process 1+Current Inventory Gap 1
 Ordering= (Adjusting Inventory + ReplacingCapacity)*Ordering
 Multiplier
 Ordering Multiplier= 1
 Desired Inventory= 90
 Adjusting Inventory= Total Inventory Gap / Target Time to Adjust Inventory
 Awareness Of Lab Inventory in Process = 1
 Current Inventory Gap= Desired Inventory-Current Lab Inventory
 Current Lab Inventory = INTEG(Procuring - Inventory Use , Desired Inventory)
 Lab Inventory In Process = INTEG(Ordering - Procuring , Target Inventory on Order)
 Lab Inventory In Process Gap= Target Inventory on Order-Lab Inventory In Process
 Perceived Inventory in Process=Lab Inventory In Process Gap*Awareness Of Lab
 Inventory in Process
 Procurement Time = 3
 Procuring = Lab Inventory In Process / Procurement Time
 ReplacingCapacity = Inventory Use
 Target Inventory on Order= Inventory Use * Procurement Time
 Target Time to Adjust Inventory= 12
 Total Inventory Gap=Perceived Inventory in Process+Current Inventory Gap

List of Acronyms

IARPA	Intelligence Advanced Research Projects Activity
FGI	Finished Goods Inventory
MIT	Massachusetts Institute of Technology
NSI	National Security Innovations
PAINT	ProActive Intelligence
SDM	System Dynamics Modeling
SME	Subject Matter Experts
WMD	Weapons of Mass Destruction